

RERK
99Z300717

Rociador empotrado rectangular de 700mm.
Rectangular recessed of 700mm.

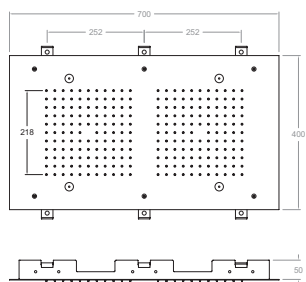

RELNRK
99Z300718

Rociador empotrado rectangular con efecto lluvia y nebulizador.
Rectangular recessed with rain and nebulizer.

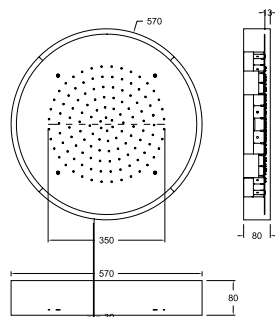

RELED570
99Z302619

Rociador empotrado redondo con efecto lluvia y cromoterapia Ø570mm.
Recessed round with rain and chromotherapy Ø570mm.

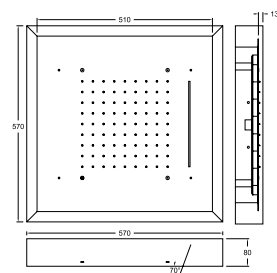
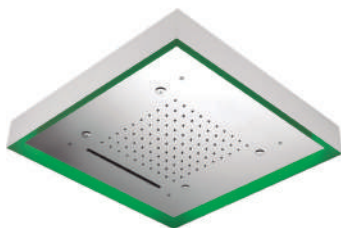

REKLEDNC570
99Z302618

Rociador empotrado cuadrado con efecto lluvia, cromoterapia, cascada y nebulizador de 570mm.
Square recessed with rain, chromotherapy, waterfall, and nebulizer Ø570mm.



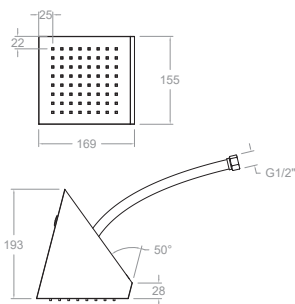

Disponible en Julio
Available in July

RIK02
99Z309173

RIK02NM
99Z309020

RIK02OC
99Z309177

RIK02CUC
99Z309179

Rociador de pared cuadrado.
Square wall showerhead.

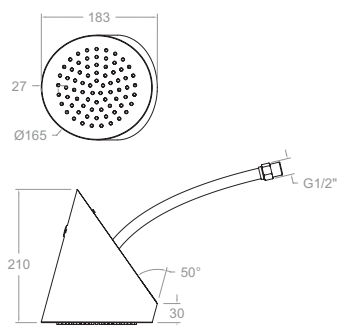
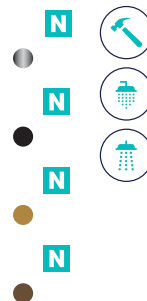

Disponible en Julio
Available in July

RIR02
99Z309180

RIR02NM
99Z309181

RIR02OC
99Z309182

RIR02CUC
99Z309183

Rociador de pared cilíndrico.
Cylindrical wall showerhead.

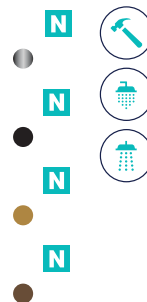

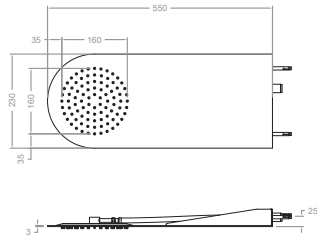

Disponible en Julio
Available in July

RR02
99Z309195

RR02NM
99Z309196

RR02OC
99Z309197

RR02CUC
99Z309198

Rociador de pared con efecto lluvia.
Wall showerhead with rain effect.

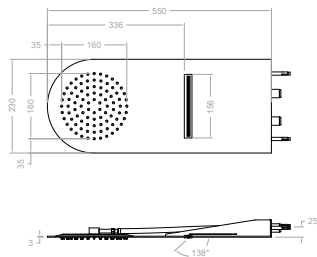
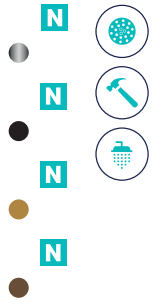

Disponible en Julio
Available in July

RCR02
99Z309191

RCR02NM
99Z309022

RCR02OC
99Z309192

RCR02CUC
99Z309194

Rociador de pared con efecto lluvia y cascada.
Wall showerhead with rain and waterfall effect.

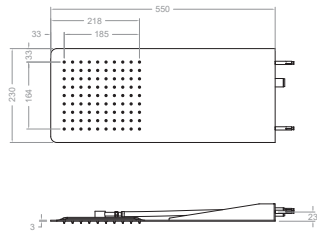
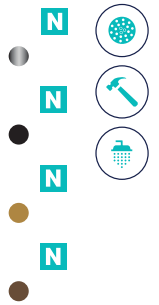

Disponible en Julio
Available in July

RRK02
99Z309187

RRK02NM
99Z309188

RRK02OC
99Z309189

RRK02CUC
99Z309190

Rociador de pared con efecto lluvia.
Wall showerhead with rain effect.

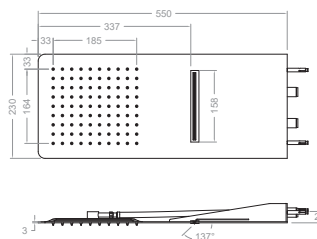
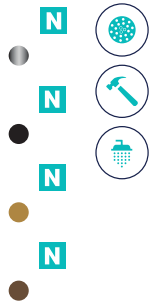

Disponible en Julio
Available in July

RCRK02
99Z309184

RCRK02NM
99Z309023

RCRK02OC
99Z309185

RCRK02CUC
99Z309186

Rociador de pared con efecto lluvia y cascada.
Wall showerhead with rain and waterfall effect.

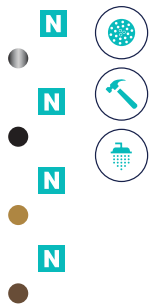





PREMIOS
NAN

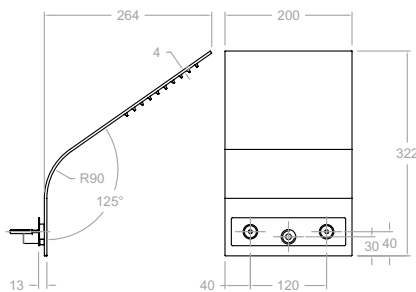
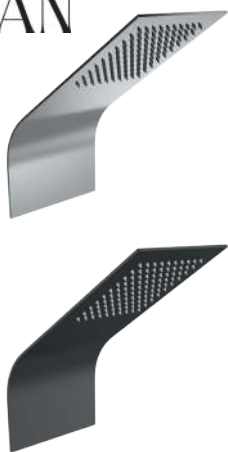

RIKS
99Z300707

RIKSNM
99Z309021

Rociador de pared inclinado.
Inclined wall showerhead.

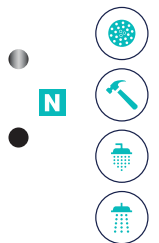

Disponible en Julio
Available in July

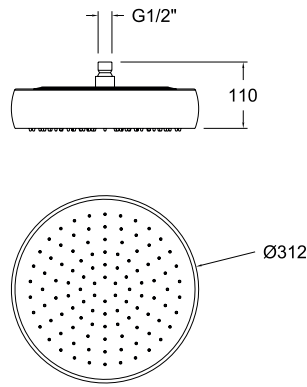

RMVOL
99Z302616

RMVOLNM
99Z305271

RMVOLNC
99Z305270

RMVOLOC
99Z305272

RMVOLCUC
99Z309106

Rociador redondo volumetrico Ø312mm.
Volumetric round Ø312mm showerhead.

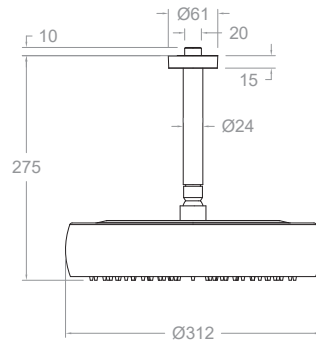
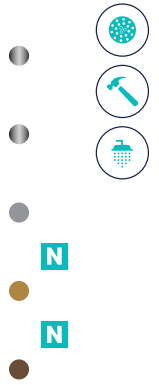

BV02RMVOL
99H309313
BV1502+RMVOL

BV02RMVOLNM
99H309314
BV1502NM+RMVOLNM

BVRMVOLNC
99H305053
BV15NC+RMVOLNC

BV02RMVOLOC
99H309316
BV1502OC+RMVOLOC

BV02RMVOLCUC
99H309317
BV1502CUC+RMVOLCUC

Conjunto de brazo de techo con rociador redondo de Ø300mm.
Set of ceiling arm with round Ø300mm showerhead.

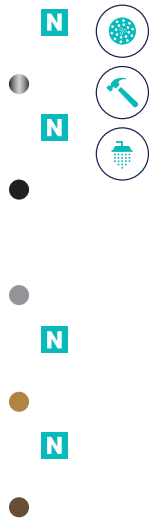

Disponible en Julio
Available in July

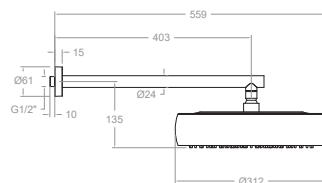

BH02RMVOL
99H309318
B400+RMVOL

BH02RMVOLNM
99H309319
B400NM+RMVOLNM

BHRMVOLNC
99H305284
B350NC+RMVOLNC

BH02RMVOLOC
99H309320
B400OC+RMVOLOC

BH02RMVOLCUC
99H309322
B400CUC+RMVOLCUC

Conjunto de brazo de pared con rociador redondo de Ø300mm.
Set of wall arm with round Ø300mm showerhead.

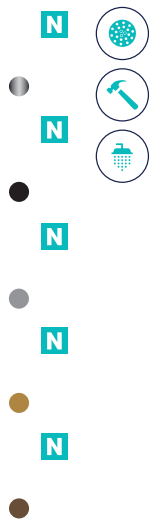

Disponible en Julio
Available in July

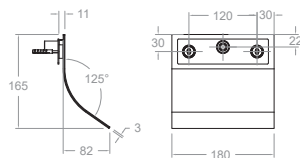
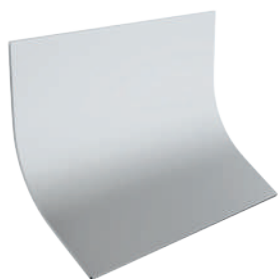

16902
99Z309101

16902NM
99Z309102

16902OC
99Z309104

16902CUC
99Z309105

Caño de cascada para lavabo empotrado.
Waterfall wall mounted basin.

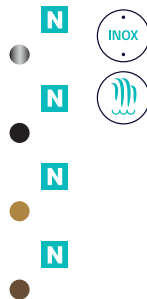

Disponible en Julio
Available in July

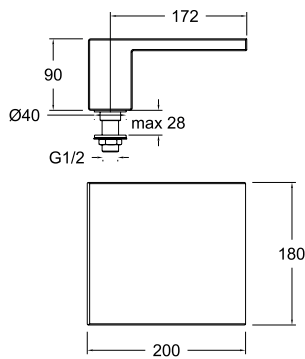
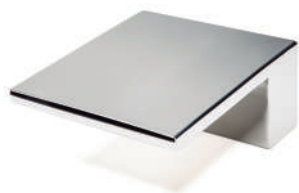

CR01
99Z302617

Caño cuadrado cascada repisa bañera.
Square spout waterfall mounted bathtub.

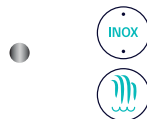

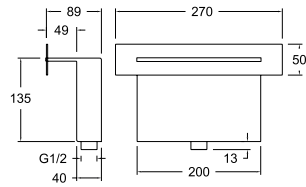

RCE02
99Z300701

Rociador de cascada empotrado.
Recessed waterfall showerhead.

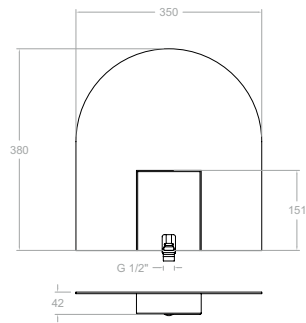

RC
99Z300698

Rociador de pared con cascada.
Wall showerhead with waterfall.

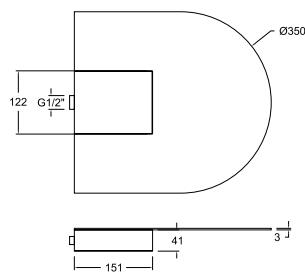

RCEXT
99Z303345

Rociador de pared con cascada para exterior.
Wall showerhead with exterior waterfall.



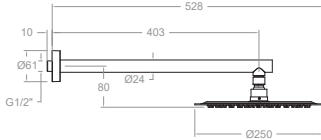

BH02RM250

99H309257
B400-RM250

N



BH02RM250NM

99H309262
B400NM-RM250NM

N



BH02RM250OC

99H309263
B400OC-RM250OC

N



Conjunto de brazo de pared con rociador redondo de Ø250mm.
Set of wall arm with round Ø250mm showerhead.

BH02RM300

99H309256
B400-RM300

N



BH02RM300NM

99H309275
B400NM-RM300NM

N



BH02RM300OC

99H309272
B400OC-RM300OC

N



BH02RM300CUC

99H309464
B400CUC-RM300CUC

N



Conjunto de brazo de pared con rociador redondo de Ø300mm.
Set of wall arm with round Ø300mm showerhead.



BH02RM400

99H309258
B400-RM400

N



Conjunto de brazo de pared con rociador redondo de Ø400mm.
Set of wall arm with round Ø400mm showerhead.

Disponible en Julio
Available in July

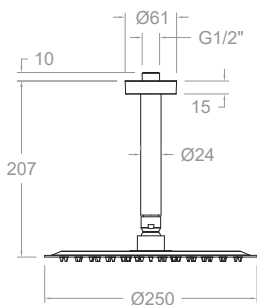

BV02RM250

99H309279
BV1502-RM250

N



BV02RM250NM

99H309284
BV1502NM-RM250NM

N



BV02RM250OC

99H309286
BV1502OC-RM250OC

N



Conjunto de brazo de techo con rociador redondo de Ø250mm.
Set of ceiling arm with round Ø250mm showerhead.

BV02RM300

99H309281
BV1502-RM300

N



BV02RM300NM

99H309287
BV1502NM-RM300NM

N



BV02RM300OC

99H309288
BV1502OC-RM300OC

N



Conjunto de brazo de techo con rociador redondo de Ø300mm.
Set of ceiling arm with round Ø300mm showerhead.



BV02RM400

99H309280
BV1502-RM400

N



Conjunto de brazo de techo con rociador redondo de Ø400mm.
Set of ceiling arm with round Ø400mm showerhead.

Disponible en Julio
Available in July

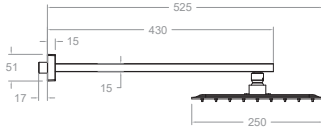

BH02RK250

99H309261
BK400+RK250



N

BH02RK250NM

99H309267
BK400NM+RK250NM



N

BH02RK250OC

99H309268
BK400OC+RK250OC



N

Conjunto de brazo de pared con rociador cuadrado de 250mm.
Set of wall arm with square 250mm showerhead.

BH02RK300

99H309253
BK400+RK300N



N

BH02RK300NM

99H309269
BK400NM+RK300NM



N

BH02RK300OC

99H309271
BK400OC+RK300OC



N

BH02RK300GR

99H309695
BK400GR+RK300GR



N

Conjunto de brazo de pared con rociador cuadrado de 400mm.
Set of wall arm with square 400mm showerhead.



BH02RK400

99H309254
BK400+RK400



N

Conjunto de brazo de pared con rociador cuadrado de 400mm.
Set of wall arm with square 400mm showerhead.

Disponible en Julio
Available in July

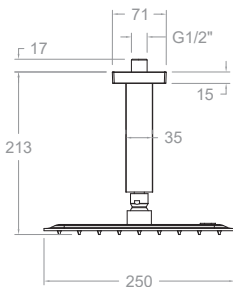

BVK02RK250

99H309296
BVK1502+RK250



N

BVK02RK250NM

99H309291
BVK1502NM+RK250NM



N

BVK02RK250OC

99H309292
BVK1502OC+RK250OC



N

Conjunto de brazo de techo con rociador cilíndrico de Ø250mm.
Set of ceiling arm with cylindrical Ø250mm showerhead.

BVK02RK300

99H309297
BVK1502+RK300N



N

BVK02RK300NM

99H309294
BVK1502NM+RK300NM



N

BVK02RK300OC

99H309295
BVK1502OC+RK300OC



N

Conjunto de brazo de techo con rociador cilíndrico de Ø300mm.
Set of ceiling arm with cylindrical Ø300mm showerhead.



BVK02RK400

99H309298
BVK1502+RK400



N

Conjunto de brazo de techo con rociador cilíndrico de Ø400mm.
Set of ceiling arm with cylindrical Ø400mm showerhead.

Disponible en Julio
Available in July

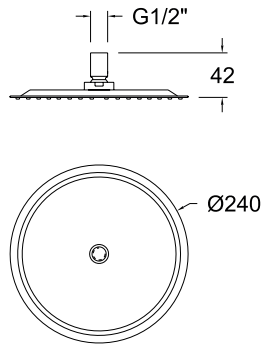

RP240
251322

RP240NM
99Z303680

Rociador redondo de Ø240mm.
Round Ø240mm showerhead.

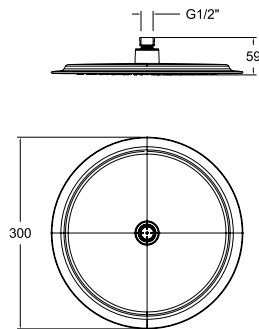
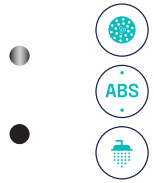

RP300
99Z303028

RP300NM
99Z303508

RP300NC
99Z307356

RP300OC
99Z307355

Rociador redondo de Ø300mm.
Round Ø300mm showerhead.

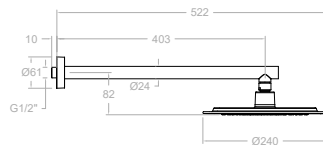
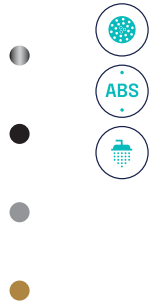

BH02RP240
99H309259
B400+RP240

BH02RP240NM
99H309277
B400NM+RP240NM

Conjunto de brazo de pared con rociador redondo de Ø240mm.
Set of wall arm with round Ø240mm showerhead.

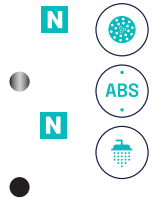

Disponible en Julio
Available in July

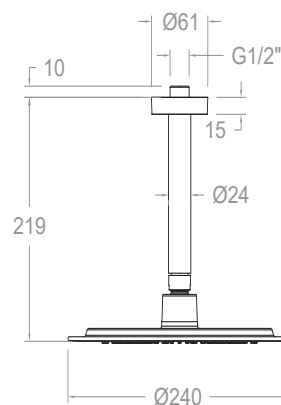

BV02RP240
99H309282
BV1502+RP240

Conjunto de brazo de techo con rociador redondo de Ø240mm.
Set of ceiling arm with round Ø240mm showerhead.

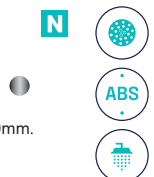

Disponible en Julio
Available in July

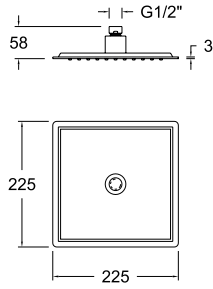
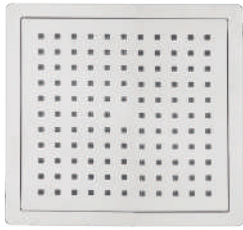

RPK225
255570

RPK225NM
99Z305097

Rociador cuadrado de 225mm.
Square 225mm showerhead.

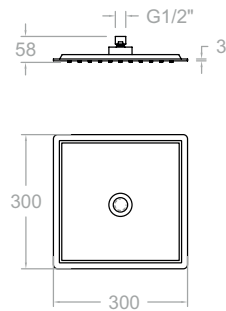
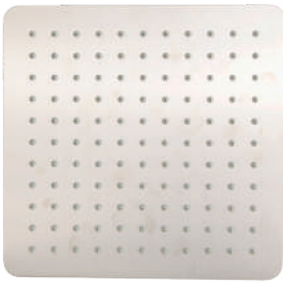

RPK300
99Z307373

RPK300NM
99Z307374

RPK300NC
99Z307377

RPK300OC
99Z307376

Rociador cuadrado de 300mm.
Square 300mm showerhead.

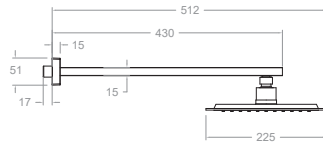

BH02RPK225
99H309260
BK400+RPK225

BH02RPK225NM
99H309276
BK400NM+RPK225NM

Conjunto de brazo de pared con rociador redondo de Ø225mm.
Set of wall arm with round Ø225mm showerhead.



Disponible en Julio
Available in July

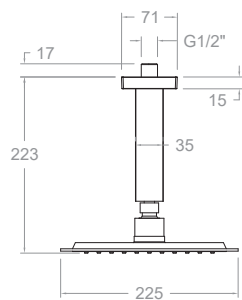

BVK02RPK225
99H309299
BVK1502+RPK225

BVK02RPK225NM
99H309300
BVK1502NM+RPK225NM

Conjunto de brazo de techo con rociador cilíndrico de Ø225mm.
Set of ceiling arm with cylindrical Ø225mm showerhead.



Disponible en Julio
Available in July

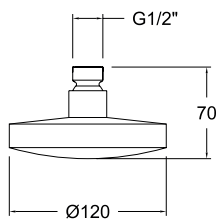

RP120

242070

Rociador redondo de Ø120mm.
Round Ø120mm showerhead.

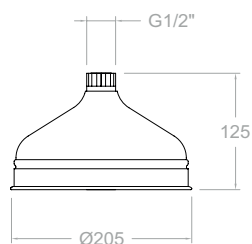

RG200

194352

Rociador redondo de Ø205mm.
Round Ø205mm showerhead.

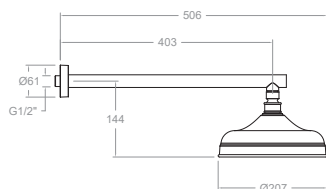

BH02RG200

99H309252

B400+RG200

Conjunto de brazo de pared con rociador redondo de Ø200 mm.
Set of wall arm with round Ø200mm showerhead.

N



Disponible en Julio
Available in July

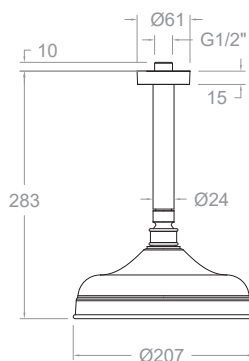

BV02RG200

99H309278

BV1502+RG200

Conjunto de brazo de techo con rociador redondo de Ø200 mm.
Set of ceiling arm with round Ø200mm showerhead.

N



Disponible en Julio
Available in July



720
156146

Brazo de ducha tubular para pared de 165 mm.
Shower arm 165 mm.

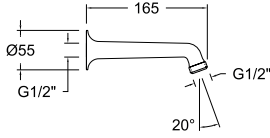

710
500684

Brazo de ducha tubular para pared de 102 mm.
Shower arm 100 mm.

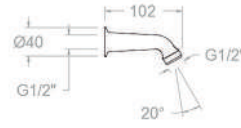

B400
99Z309001

B400NM
99Z309002

B400OC
99Z309003

B400CUC
99Z309005

Brazo de ducha para pared redondo de 400 mm.
Round wall shower arm 400 mm.



Disponible en Julio
Available in July

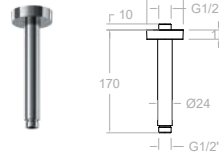

BV1502
99Z308992

BV1502NM
99Z308994

BV1502OC
99Z308993

BV1502CUC
99Z308996

Brazo de ducha para techo redondo de 150 mm.
Round ceiling shower arm 150 mm.

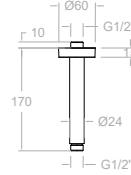

Disponible en Julio
Available in July

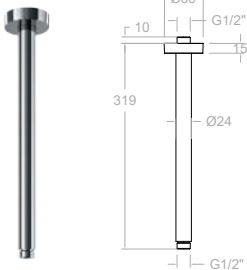

BV300
99Z308997

BV300NM
99Z308999

BV300OC
99Z308998

BV300CUC
99Z309000

Brazo de ducha para techo redondo de 300 mm.
Round ceiling shower arm 300 mm.

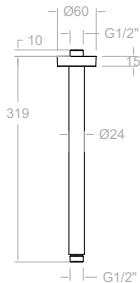

Disponible en Julio
Available in July



BK400
99Z309014

BK400NM
99Z309015

BK400OC
99Z309016

BK400CUC
99Z309017

BK400GR
99Z309692

Brazo de ducha para pared cuadrado de 400 mm.
Wall shower square arm 400 mm.

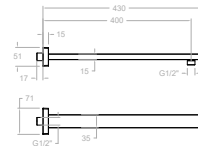

Disponible en Julio
Available in July

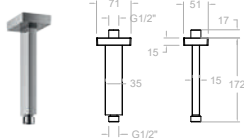

BVK1502
99Z309006

BVK1502NM
99Z309008

BVK1502OC
99Z309007

BVK1502CUC
99Z309009

Brazo de ducha para techo cuadrado de 165 mm.
Square ceiling shower arm 150 mm.

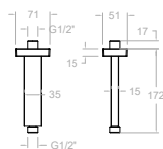

Disponible en Julio
Available in July

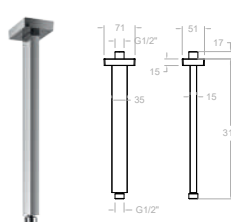

BVK300
99Z309010

BVK300NM
99Z309012

BVK300OC
99Z309011

BVK300CUC
99Z309013

Brazo de ducha para techo cuadrado de 300 mm.
Square ceiling shower arm 300 mm.

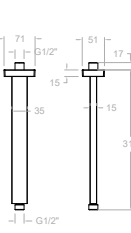

Disponible en Julio
Available in July



Alexia

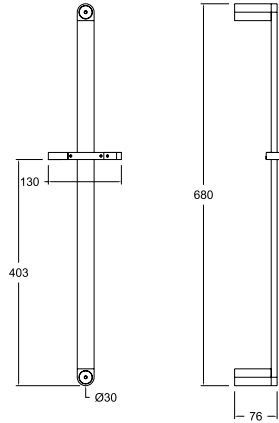

- 776001S**
99Z302193
- 776001SNM**
99Z302158
- 776001SNC**
99Z303565
- 776001SOC**
99Z303547

Barra de ducha semi redonda 70 cm sin accesorios.
Semi round shower bar 70 cm without accessories.

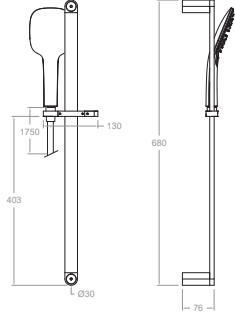

- 776001Q3**
99H309240
776001S+4914Q3+2472C
- 776001Q3NM**
99H309241
776001SNM+4914Q3NM+2475CNM
- 776001Q3NC**
99H309243
776001SNC+4914Q3NC+2475CNC
- 776001Q3OC**
99H309242
776001SOC+4914Q3+2475COC

Barra de ducha semi redonda con accesorios.
Semi round shower bar with accessories.

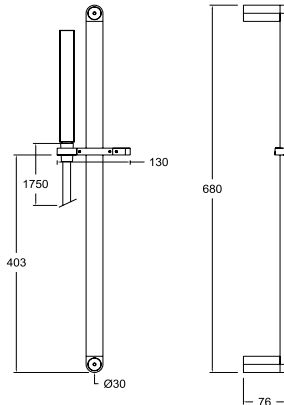

- 776001MO**
99H304971
776001S+3713M+2471C
- 776001DNM**
99H304968
776001SNM+3714NM+2475CNM
- 776001DNC**
99H304969
776001SNC+3714NC+2475CNC
- 776001DOC**
99H304970
776001SOC+3714OC+2475COC

Barra de ducha semi redonda con accesorios.
Semi round shower bar with accessories.

Zenit

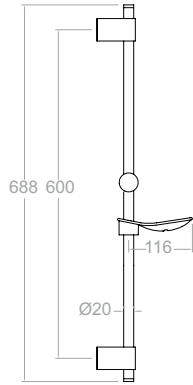

7750S
227436

Barra de ducha de latón, soporte deslizante ABS sin accesorios.
Brass shower bar, without accessories.



7750MO
256551

7750S+3713M+2471C

7750T1
300133

7750S+3520T1+2471C

7750T3
256542

7750S+5840T3+2471C

7750TR
99H301347

7750S+2877TR+2471C

Barra de ducha con accesorios.
Shower bar with accessories.



Universal

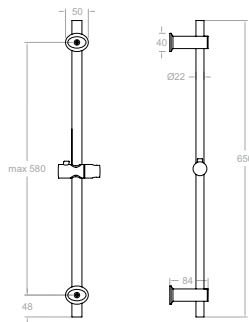

778002S
99Z307769

778002SNM
99Z307770

Barra de ducha sin accesorios, con un soporte de fijación a pared adaptable.
Shower bar without accessories, with adaptable wall bracket.



778002BT
99H307774

778002S+2876BT+1128C

778002BTNM
99H307775

778002SNM+2876BTNM+2475CNM

778002T1
99H307820

778002S+3520T1+1128C

778002VP
99H307776

778002S+351502+245002C

Barra de ducha con accesorios.
Shower bar with accessories.



Universal Plus

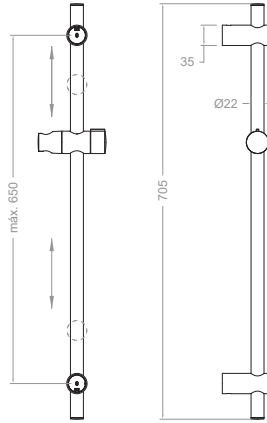

377303S
99Z309145

377303SNM
99Z309062

377303SNC
99Z309024

377303SOC
99Z309146

377303SCUC
99Z309147

Barra de ducha con ambos soportes de fijación a pared adaptables sin accesorios.
Shower bar with both wall brackets adaptable without accessories.

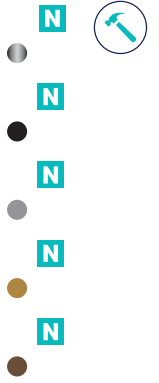

Disponible en Julio
Available in July

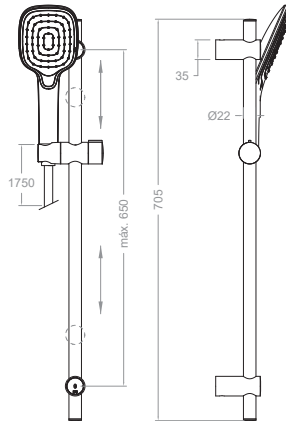

377303Q3
99H309227

377303Q3NM
99H309228

377303Q3NC
99H309232

377303Q3OC
99H309230

377303Q3CUC
99H309231

Barra de ducha con ambos soportes de fijación a pared adaptables con accesorios Q3.
Shower bar with both wall brackets adaptable with Q3 accessories.

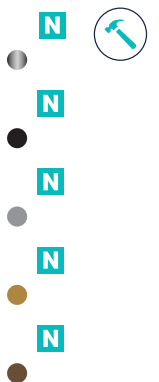

Disponible en Julio
Available in July

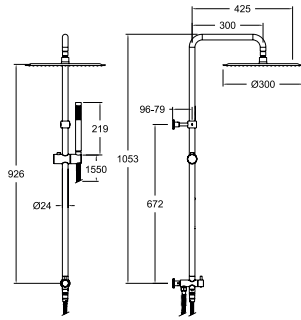

T20002RM300

99H302793

T100D+RD04M+IDP16+SFT24IDP16+RM300+3713M+1122CHP+1128C ●

Barra de ducha adaptable con teleducha, flexo y rociador de metal Ø300mm.

Adaptable shower with spray shower.

T20002RM250

99H302792

T100D+RD04M+IDP16+SFT24IDP16+RM250+3713M+1122CHP+1128C ●

Barra de ducha adaptable con teleducha, flexo y rociador de metal Ø250mm.

Adaptable shower with spray shower.

T20002RP240

99H302791

T100D+RD04M+IDP16+SFT24IDP16+RP240+3520T1+1122CHP+1128C ●

Barra de ducha adaptable con teleducha, flexo y rociador ABS Ø240mm.

Adaptable shower bar with hand shower, hose and ABS shower head Ø240mm.

T20002RPK225

99H302794

T100D+RD04M+IDP16+SFT24IDP16+RPK225+4716PR+1122CHP+1128C ●

Barra de ducha adaptable con teleducha, flexo y rociador ABS cuadrado de 225mm.

Adaptable shower bar with hand shower, hose and 225mm square ABS shower head.

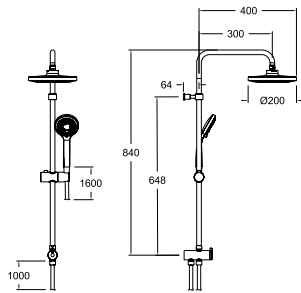

T20003RP200

99H303260

T200D+IDP1/2P+RP200+2876BT+245002C+1122CHP ●

Barra de ducha adaptable con teleducha, flexo y rociador ABS de Ø200mm.

Adaptable shower bar with hand shower, hose and ABS shower head Ø200mm.

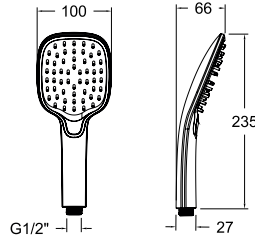

4914Q3

99Z306272

4914Q3NM

99Z306274

4914Q3NC

99Z307382

4914Q3OC

99Z306276

4914Q3CUC

99Z309233

4914Q3GR

99Z309091

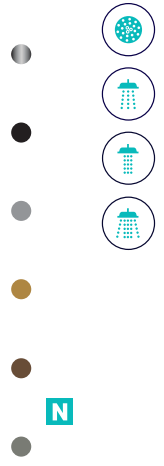

Ducha de mano ABS de 3 funciones.
ABS hand shower with 3 functions.

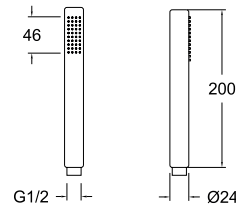

3713M

255597

3714NM

99Z302151

3714NC

99Z302329

3714OC

99Z302152

3714CUC

99Z307560

3714GR

99Z309089



Ducha de mano de latón con 1
función.
Brass hand shower with 1 function.

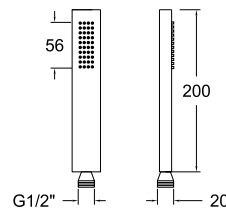
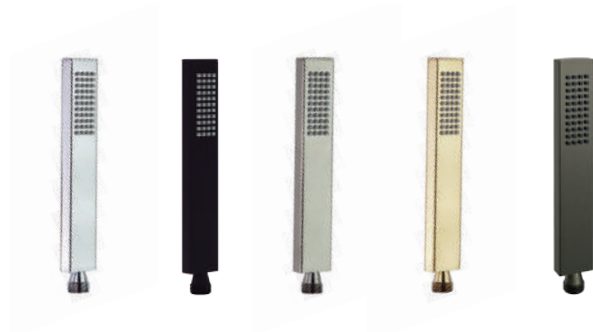

4716MR

4716MRNM

99Z305012

4716MRNC

99Z304946

4716MROC

99Z304947

4716MRGR

99Z309675

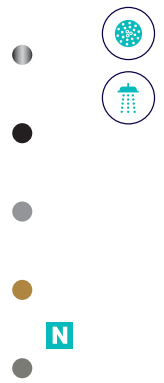

Ducha de mano de latón con 1
función.
Brass hand shower with 1 function.



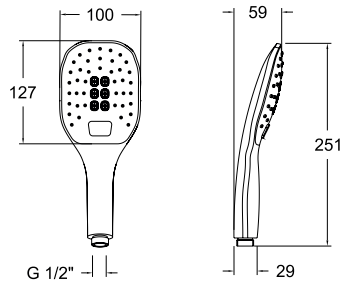

4913K3

99Z302621

Ducha de mano de ABS con 3 funciones.
ABS hand shower with 3 functions.



2877TR

99Z300776

Ducha de mano de ABS con 3 funciones.
ABS hand shower with 3 functions.

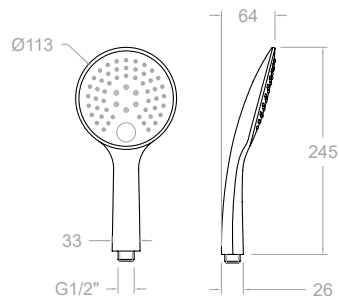

2876BT

261595

2876BTNM

99Z303717

Ducha de mano de ABS con 3 funciones.
ABS hand shower with 3 functions.

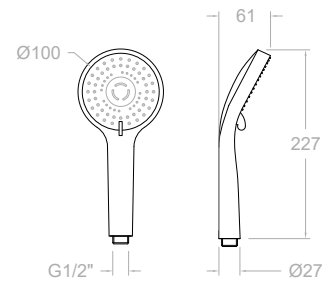

5840T3

261594

Ducha de mano de ABS con 3 funciones.
ABS hand shower with 3 functions.

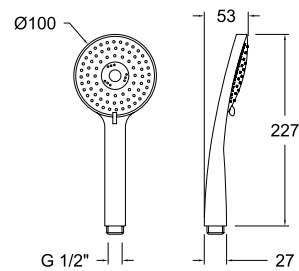

5811AS

261592

Ducha de mano de ABS con 3 funciones.
ABS hand shower with 3 functions.

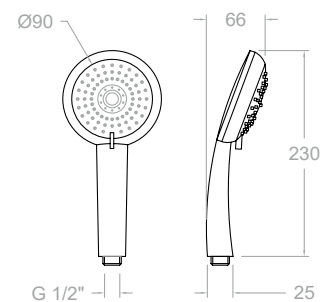



4716PR
99Z305013

4716PRNM
99Z304945

Ducha de mano de ABS con 1 función.
ABS hand shower with 1 function.

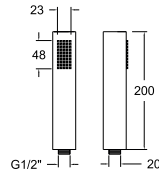

3713P
196674

3713PNM
99Z304939

Ducha de mano de ABS con 1 función.
ABS hand shower with 1 function.

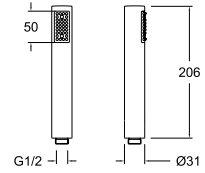

3520T1
261593

Ducha de mano de ABS con 1 función.
ABS hand shower with 1 function.

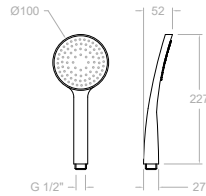

3521NL
241377

Ducha de mano de ABS con 1 función.
ABS hand shower with 1 function.

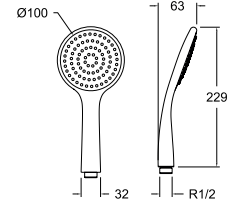

351502
99Z305273

Ducha de mano de ABS con 1 función.
ABS hand shower with 1 function.

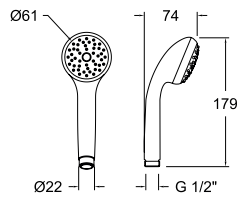

1224
179232

Ducha de mano de ABS con 1 función.
ABS hand shower with 1 function.

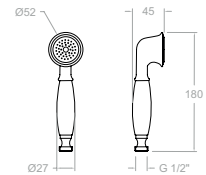

3518
229722

Ducha de mano de ABS con 1 función.
ABS hand shower with 1 function.

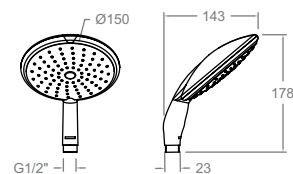

3524D1
99Z306239

Ducha de mano de ABS con 1 función.
ABS hand shower with 1 function.

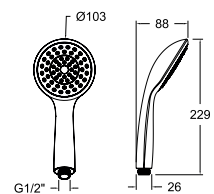



3726M
261799



372602NM
99Z302672



372602NC
99Z302671



372602OC
99Z302673



372602CUC
99Z307677



372602GR
99Z309088



Soporte metálico de pared para ducha.
Metal shower wall support.

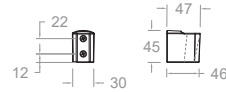
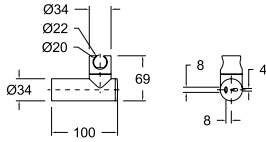

4727
99Z309456



4727NM
99Z309458



4727NC
99Z309460



4727OC
99Z309459



4727CUC
99Z309461



Soporte de ABS de pared para ducha.
ABS shower wall support.



4726M
261800



472602NM
99Z302581



472602NC
99Z304949



472602OC
99Z304950



472602GR
99Z309673



Soporte metálico de pared para ducha.
Metal shower wall support.

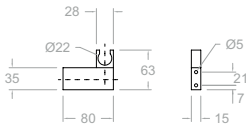

354802
99Z302082



354802NM
99Z309136



354802NC
99Z309025



354802OC
99Z309026



354802CUC
99Z309027



Soporte de pared para ducha.
Shower support.

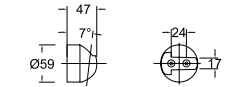

4741
300152



4741NM
99Z306003



Soporte metálico de pared para ducha.
Metal shower wall support.

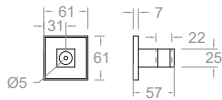

3726
196701



3726NM
99Z304940



Soporte ABS de pared para ducha.
ABS shower wall support.

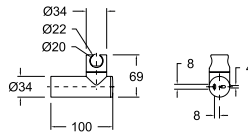

4726
212064



4726NM
99Z304948



Metal shower wall support.
Soporte metálico de pared para ducha.

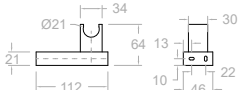

3544
99Z300793



Soporte ABS de pared para ducha.
ABS shower wall support.

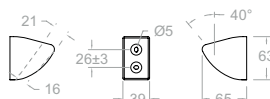

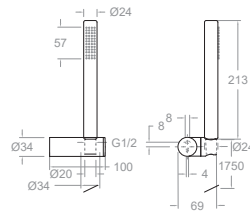

3749MO

256344

3713M+3726M+2471C



3749DNM

99H304941

3714NM+372602NM+2475CNM



3749DNC

99H304942

3714NC+372602NC+2475CNC



3749DOC

99H304943

3714OC+372602OC+2475COC



Conjunto de ducha con ducha de mano, flexible para ducha, y soporte de pared.

Shower set with handshower, flexible connection and wall bracket.

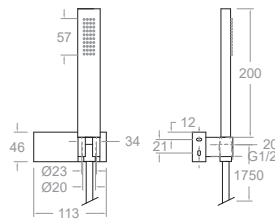

4749MR

99H305014

4716MR+4726M+2471C



4759MRNM

99H304951

4716MRNM+472602NM+2475CNM



4759MRNC

99H304952

4716MRNC+472602NC+2475CNC



4759MROC

99H304956

4716MROC+472602OC+2475COC



Conjunto de ducha con ducha de mano, flexible para ducha, y soporte de pared.

Shower set with handshower, flexible connection and wall bracket.

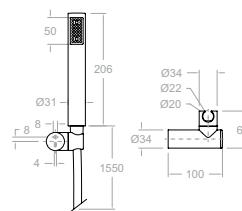

3349D

218895

3713P+3726+1128C



3349PONM

99H304938

3713PNM+3726NM+2475CNM



Conjunto de ducha con ducha de mano, flexible para ducha, y soporte de pared.

Shower set with handshower, flexible connection and wall bracket.



4781PR

99H308116
4716PR+4796+2471C

Conjunto de ducha de pared con ducha de mano, flexible para ducha, codo con soporte y salida de agua.
Wall mounted shower set with hand shower, shower hose, elbow with bracket and water outlet.



4749PR

99H304957
4716PR+4726+1128C

4749PRNM

99H304958
4716PRNM+4726NM+2475CNM

Conjunto de ducha con ducha de mano, flexible para ducha, y soporte de pared.
Shower set with handshower, flexible connection and wall bracket.



4950K3

99H302624
4913K3+3726M+2472C

Conjunto de ducha con ducha de mano, flexible para ducha, y soporte de pared.
Shower set with handshower, flexible connection and wall bracket.



4949K1

99H302622
4912K1+3726M+2472C

Conjunto de ducha con ducha de mano, flexible para ducha, y soporte de pared.
Shower set with handshower, flexible connection and wall bracket.



5812T3

257460
5840T3+3726+1128C

Conjunto de ducha con ducha de mano, flexible para ducha, y soporte de pared.
Shower set with handshower, flexible connection and wall bracket.



3553T1

257451
3520T1+3726+1128C

Conjunto de ducha con ducha de mano, flexible para ducha, y soporte de pared.
Shower set with handshower, flexible connection and wall bracket.



5813TR

99H300777
2877TR+3726M+2472C

Conjunto de ducha con ducha de mano, flexible para ducha, y soporte de pared.
Shower set with handshower, flexible connection and wall bracket.



3551NL

241395
3521NL+3726+1128C

Conjunto de ducha con ducha de mano, flexible para ducha, y soporte de pared.
Shower set with handshower, flexible connection and wall bracket.



3558MS

229902
3518+3726+1128C

Conjunto de ducha con ducha de mano, flexible para ducha, y soporte de pared.
Shower set with handshower, flexible connection and wall bracket.



5849AS

241386
5811AS+3726+2471C

Conjunto de ducha con ducha de mano, flexible para ducha, y soporte de pared.
Shower set with handshower, flexible connection and wall bracket.



3792M
99H301349
3713M+3796+2471C ●

3792DNM
99H308112
3796NM+3714NM+2475CNM ●

3792DNC
99H308114
3796NC+3714NC+2475CNC ●

3792DOC
99H308115
3796OC+3714OC+2475COC ●

Conjunto de ducha de pared con ducha de mano, flexible para ducha, codo con soporte y salida de agua.
Wall mounted shower set with hand shower, shower hose, elbow with bracket and water outlet.



4792MR
99H309234
4716MR+4796+2471C ●

4792MRNM
99H302167
4714KNM+4798NM+2475CNM ●

4792MRNC
99H308121
4798NC+4716MRNC+2475CNC ●

4792MROC
99H308123
4798OC+4716MROC+2475COC ●

Conjunto de ducha de pared con ducha de mano, flexible para ducha, codo con soporte y salida de agua.
Wall mounted shower set with hand shower, shower hose, elbow with bracket and water outlet.



3782BT
99H308106
2876BT+3796+2471C ●

3782BTNM
99H308107
2876BTNM+3796NM+2475CNM ●

Conjunto de ducha de pared con ducha de mano, flexible para ducha, codo con soporte y salida de agua.
Wall mounted shower set with hand shower, shower hose, elbow with bracket and water outlet.



3981P
99H308105
3713P+3796+2471C ●

Conjunto de ducha de pared con ducha de mano, flexible para ducha, codo con soporte y salida de agua.
Wall mounted shower set with hand shower, shower hose, elbow with bracket and water outlet.



655402VM2
99H305276
351502+3544+1128C ●

Conjunto de ducha con ducha de mano, flexible para ducha, y soporte de pared.
Shower set with handshower, flexible connection and wall bracket.



655302VP2
99H305275
351502+3544+245002C ●

Conjunto de ducha con ducha de mano, flexible para ducha, y soporte de pared.
Shower set with handshower, flexible connection and wall bracket.



3049G
197043
1224+1126+1128C ●

Conjunto de ducha con ducha de mano, flexible para ducha, y soporte de pared.
Shower set with handshower, flexible connection and wall bracket.

Instalación sistema dual

FIJACIÓN MECÁNICA

- Posicionar los puntos donde taladrar.
- Atornillar la pieza de unión fuertemente en cada taco.
- Introducir el accesorio en las piezas de unión y fijar fuertemente con el tornillo prisionero.

FIJACIÓN ADHESIVA

Sealant fix: ¡Olvídate de agujerear las paredes con el pegamento Sealant fix!

- Fácil de aplicar, fácil de retirar.
- Resistente al agua.
- No tóxico.

OPCIONAL: Se pueden aplicar ambos sistemas de fijación a la vez.

Dual system installation

MECHANICAL FIXING

- Position the points where to drill.
- Screw the connecting piece tightly into each anchor.
- Insert the accessory in the connecting pieces and fix it with the set screw.

ADHESIVE FIXATION

Sealant fix: Forget about drill the walls with Sealant Fix glue!

- Easy to apply, easy to remove.
- Waterproof.
- Not toxic.

OPTIONAL: Both fixing systems can be applied at the same time.



CR



NM



IC



OC



CUC



GR

Acabado grafito disponible en Julio
Gun metal finish available in July

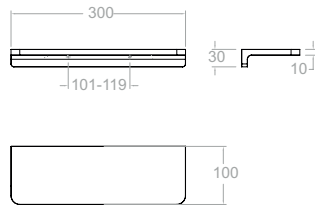

ESTA01
99Z308819

Ergos, estante de pared para baño.
Ergos, wall shelf.

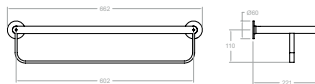

TOAL03
99Z306201

Ergos, toallero estante tamaño XL para baño con Sistema de Instalación Dual.
Ergos, towel rack shelf (XL) with Dual Installation System.



TOAL02
99Z306197

Ergos, toallero tamaño XL para baño con Sistema de Instalación Dual.
Ergos, towel rack (XL) with Dual Installation System.



TOAL04
99Z307448

Ergos, toallero tamaño L para baño con Sistema de Instalación Dual.
Ergos, towel rack (L) with Dual Installation System.

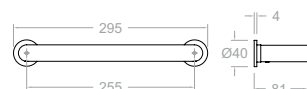

TOAL01
99Z306193

Ergos, toallero tamaño M para baño con Sistema de Instalación Dual.
Ergos, towel rack (M) with Dual Installation System.

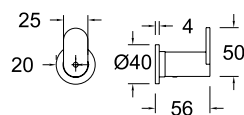

COLG01
99Z306189

Ergos, colgador para baño con Sistema de Instalación Dual.
Ergos, hook with Dual Installation System.



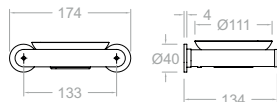

SOP02
99Z306209

Ergos, jabonera de pared de pared para baño con Sistema de Instalación Dual.
Ergos, soap dish with Dual Installation System.

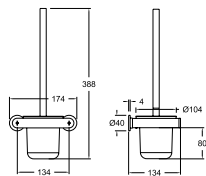

ESCO01
99Z306213

Ergos, escobillero de pared para baño con Sistema de Instalación Dual.
Ergos, toilet brush with Dual Installation System.

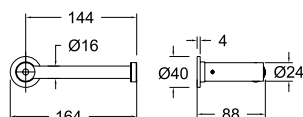

PORT01
99Z306217

Ergos, portarollos de pared para baño con Sistema de Instalación Dual.
Ergos, paper holder with Dual Installation System.

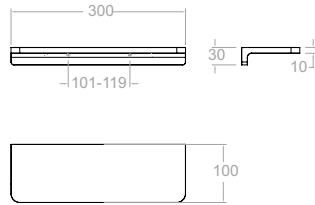

ESTA01NM

99Z308822

Ergos, estante de pared para baño.
Ergos, wall shelf.

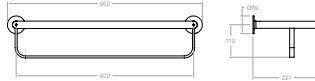

TOAL03NM

99Z306202

Ergos, toallero estante tamaño XL para baño con Sistema de Instalación Dual.
Ergos, towel rack shelf (XL) with Dual Installation System.

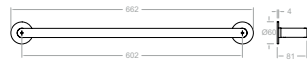

TOAL02NM

99Z306198

Ergos, toallero tamaño XL para baño con Sistema de Instalación Dual.
Ergos, towel rack (XL) with Dual Installation System.

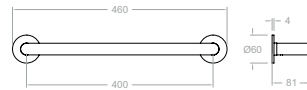

TOAL04NM

99Z307449

Ergos, toallero tamaño L para baño con Sistema de Instalación Dual.
Ergos, towel rack (L) with Dual Installation System.

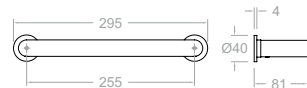

TOAL01NM

99Z306194

Ergos, toallero tamaño M para baño con Sistema de Instalación Dual.
Ergos, towel rack (M) with Dual Installation System.

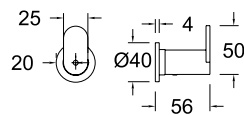

COLG01NM

99Z306190

Ergos, colgador para baño con Sistema de Instalación Dual.
Ergos, hook with Dual Installation System.

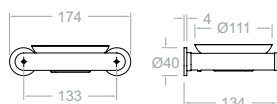

SOP02NM

99Z306210

Ergos, jabonera de pared para baño con Sistema de Instalación Dual.

Ergos, soap dish with Dual Installation System.

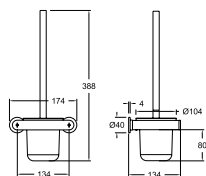

ESCO01NM

99Z306214

Ergos, escobillero de pared para baño con Sistema de Instalación Dual.

Ergos, toilet brush with Dual Installation System.

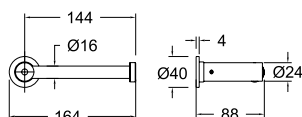

PORT01NM

99Z306218

Ergos, portarrollos de pared para baño con Sistema de Instalación Dual.

Ergos, paper holder with Dual Installation System.

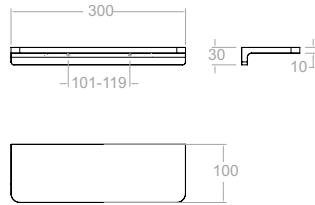

ESTA01IC
99Z308824

N

Ergos, estante de pared para baño.
Ergos, wall shelf.

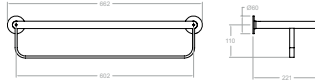

TOAL03IC
99Z306204

Ergos, toallero estante tamaño XL para baño con Sistema de Instalación Dual.
Ergos, towel rack shelf (XL) with Dual Installation System.



TOAL02IC
99Z306200

Ergos, toallero tamaño XL para baño con Sistema de Instalación Dual.
Ergos, towel rack (XL) with Dual Installation System.

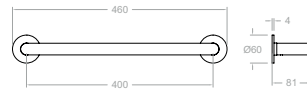

TOAL04IC
99Z307450

Ergos, toallero tamaño L para baño con Sistema de Instalación Dual.
Ergos, towel rack (L) with Dual Installation System.

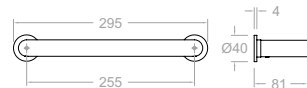

TOAL01IC
99Z306196

Ergos, toallero tamaño M para baño con Sistema de Instalación Dual.
Ergos, towel rack (M) with Dual Installation System.

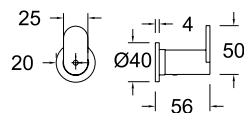

COLG01IC
99Z306192

Ergos, colgador para baño con Sistema de Instalación Dual.
Ergos, hook with Dual Installation System.

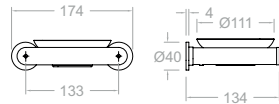

SOP02IC
99Z306212

Ergos, jabonera de pared para baño con Sistema de Instalación Dual.
Ergos, soap dish with Dual Installation System.

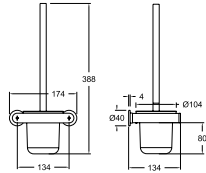

ESCO01IC
99Z306216

Ergos, escobillero de pared para baño con Sistema de Instalación Dual.
Ergos, toilet brush with Dual Installation System.

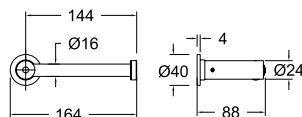

PORT01IC
99Z306220

Ergos, portarrollos de pared para baño con Sistema de Instalación Dual.
Ergos, paper holder with Dual Installation System.

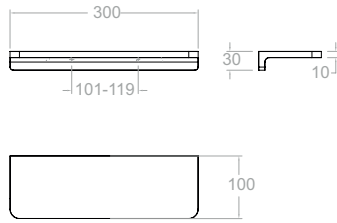

ESTA010C

99Z308823

Ergos, estante de pared para baño.
Ergos, wall shelf.

N

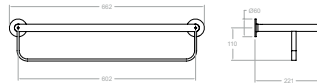

TOAL030C

99Z306203

Ergos, toallero estante tamaño XL para baño con Sistema de Instalación Dual.
Ergos, towel rack shelf (XL) with Dual Installation System.



TOAL020C

99Z306199

Ergos, toallero tamaño XL para baño con Sistema de Instalación Dual.
Ergos, towel rack (XL) with Dual Installation System.



TOAL040C

99Z307451

Ergos, toallero tamaño L para baño con Sistema de Instalación Dual.
Ergos, towel rack (L) with Dual Installation System.

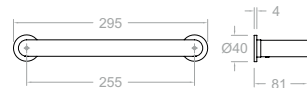

TOAL010C

99Z306195

Ergos, toallero tamaño M para baño con Sistema de Instalación Dual.
Ergos, towel rack (M) with Dual Installation System.

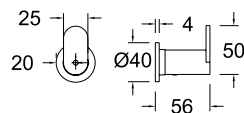

COLG010C

99Z306191

Ergos, colgador para baño con Sistema de Instalación Dual.
Ergos, hook with Dual Installation System.



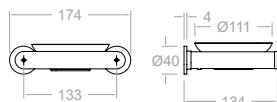
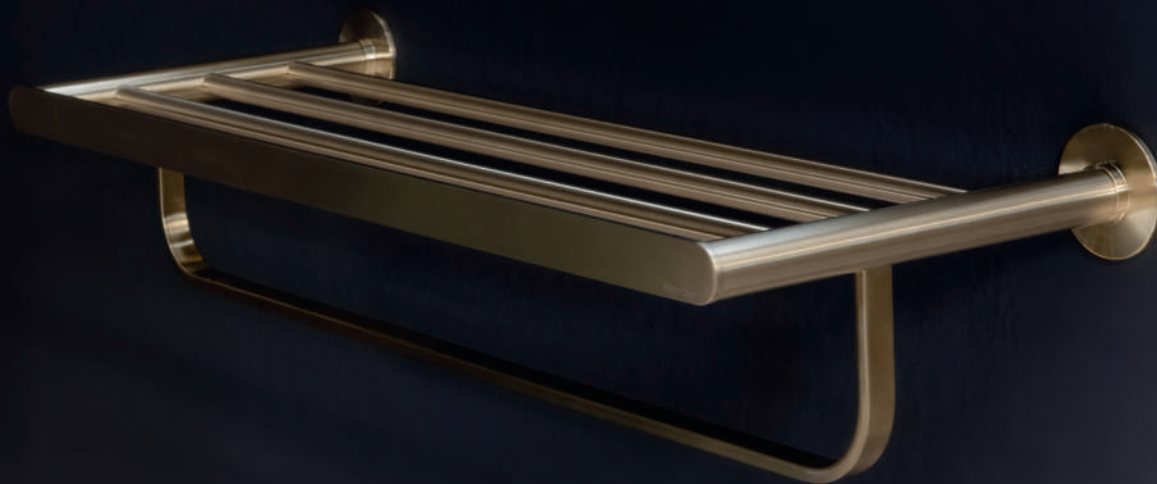

SOP020C

99Z306211

Ergos, jabonera de pared de pared para baño con Sistema de Instalación Dual.

Ergos, soap dish with Dual Installation System.

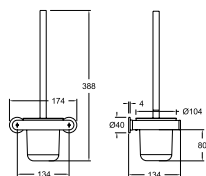

ESCO010C

99Z306215

Ergos, escobillero de pared para baño con Sistema de Instalación Dual.

Ergos, toilet brush with Dual Installation System.

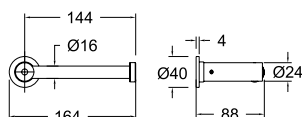

PORT010C

99Z306219

Ergos, portarrollos de pared para baño con Sistema de Instalación Dual.

Ergos, paper holder with Dual Installation System.

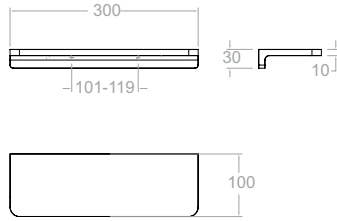

ESTA01CUC

99Z308825

Ergos, estante de pared para baño.
Ergos, wall shelf.

N

Disponible en Julio
Available in July

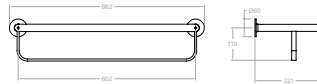

TOAL03CUC

99Z308449

Ergos, toallero estante tamaño XL para baño con Sistema de Instalación Dual.
Ergos, towel rack shelf (XL) with Dual Installation System.

N

Disponible en Julio
Available in July



TOAL02CUC

99Z308448

Ergos, toallero tamaño XL para baño con Sistema de Instalación Dual.
Ergos, towel rack (XL) with Dual Installation System.

N

Disponible en Julio
Available in July



TOAL04CUC

99Z308450

Ergos, toallero tamaño L para baño con Sistema de Instalación Dual.
Ergos, towel rack (L) with Dual Installation System.

N

Disponible en Julio
Available in July

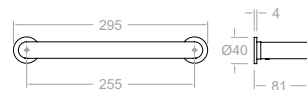
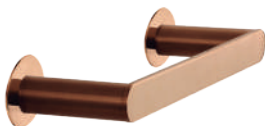

TOAL01CUC

99Z308447

Ergos, toallero tamaño M para baño con Sistema de Instalación Dual.
Ergos, towel rack (M) with Dual Installation System.

N

Disponible en Julio
Available in July

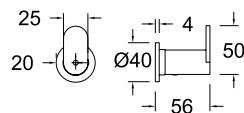

COLG01CUC

99Z308451

Ergos, colgador para baño con Sistema de Instalación Dual.
Ergos, hook with Dual Installation System.

N

Disponible en Julio
Available in July

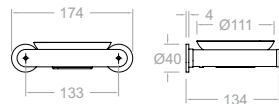

SOP02CUC

99Z308452

Ergos, jabonera de pared de pared para baño con Sistema de Instalación Dual.

Ergos, soap dish with Dual Installation System.

Disponible en Julio
Available in July

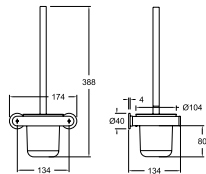

ESCO01CUC

99Z308454

Ergos, escobillero de pared para baño con Sistema de Instalación Dual.

Ergos, toilet brush with Dual Installation System.

Disponible en Julio
Available in July

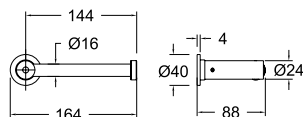

PORT01CUC

99Z308453

Ergos, portarrollos de pared para baño con Sistema de Instalación Dual.

Ergos, paper holder with Dual Installation System.

Disponible en Julio
Available in July

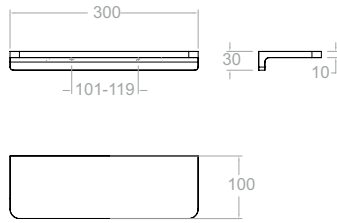

ESTA01GR

99Z308826

Ergos, estante de pared para baño.
Ergos, wall shelf.

N

Disponible en Julio
Available in July

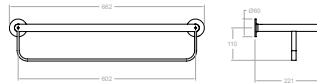

TOAL03GR

99Z308457

Ergos, toallero estante tamaño XL para baño con Sistema de Instalación Dual.
Ergos, towel rack shelf (XL) with Dual Installation System.

N

Disponible en Julio
Available in July



TOAL02GR

99Z308456

Ergos, toallero tamaño XL para baño con Sistema de Instalación Dual.
Ergos, towel rack (XL) with Dual Installation System.

N

Disponible en Julio
Available in July



TOAL04GR

99Z308458

Ergos, toallero tamaño L para baño con Sistema de Instalación Dual.
Ergos, towel rack (L) with Dual Installation System.

N

Disponible en Julio
Available in July

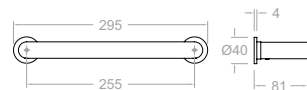

TOAL01GR

99Z308455

Ergos, toallero tamaño M para baño con Sistema de Instalación Dual.
Ergos, towel rack (M) with Dual Installation System.

N

Disponible en Julio
Available in July

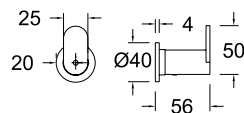

COLG01GR

99Z308460

Ergos, colgador para baño con Sistema de Instalación Dual.
Ergos, hook with Dual Installation System.

N

Disponible en Julio
Available in July

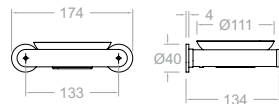

SOP02GR

99Z308463

N

Ergos, jabonera de pared de pared para baño con Sistema de Instalación Dual.

Ergos, soap dish with Dual Installation System.

Disponible en Julio
Available in July

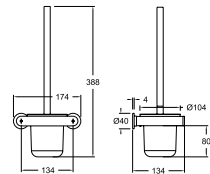

ESCO01GR

99Z308466

N

Ergos, escobillero de pared para baño con Sistema de Instalación Dual.

Ergos, toilet brush with Dual Installation System.

Disponible en Julio
Available in July

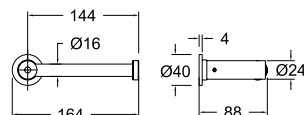

PORT01GR

99Z308465

N

Ergos, portarrollos de pared para baño con Sistema de Instalación Dual.

Ergos, paper holder with Dual Installation System.

Disponible en Julio
Available in July



VER VÍDEO



WATCH VIDEO

W/C

Características Técnicas

- Previene los escapes por presión estática en flexo y duchita.
- Evita siniestros por inundaciones.
- Evita recirculación del agua.
- Montaje en dos cuerpos.
- Garantía de 5 años en grifería y 2 años en complementos.

Technical Characteristics

- Prevents leakage by static pressure in the flexible and shower.
- Avoid damages by floods.
- Avoid water recirculation.
- Assembly in two bodies.
- 5 years warranty on taps and 2 years on accessories.



WC



CR



NM



NC



OC





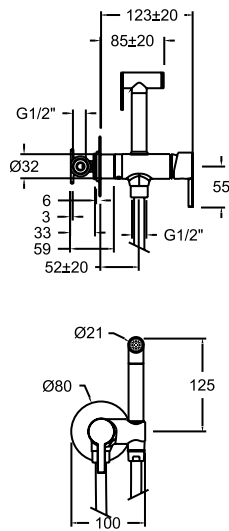

336801WC

99F302081
336801S+9552+1120CHP

336801WCNM

99F305564
336801SNM+9552NM+1121CNM

336801WCNC

99F305571
336801SNC+9552NC+1121CNC

336801WCOC

99F305569
336801SOC+9552OC+1121CO

Monomando empotrado de WC Magnet con cierre doble cierre de seguridad y duchita.

Single lever WC Magnet with double closing safety lock and shower.



336801S

99F302575
XX6801+3300-25

336801SNM

99F305561
XX6801NM+3300-25NM

336801SNC

99F305570
XX6801NC+3300-25NC

336801SOC

99F305568
XX6801OC+3300-25OC

Monomando empotrado de WC Magnet con cierre doble cierre de seguridad sin accesorios.

Single lever WC Magnet with double closing safety lock without accessories.

Cartucho Cartridge: 25000-2



PME01

AAZ302651

Placa necesaria para montaje en pladur.
Plate needed for mounting in plasterboard.

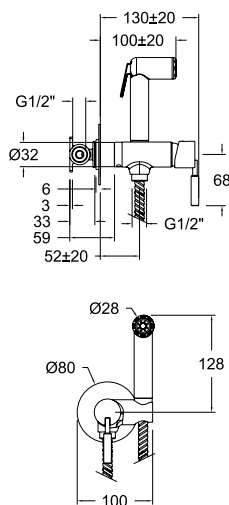

756801WC

99F302574
756801S+955102+247903C

Monomando empotrado de WC Magnet con cierre doble cierre de seguridad y duchita.

Single lever WC magnet with double closing safety lock and shower..

756801S

99F302573
XX6801+7500-25

Monomando empotrado de WC Magnet con cierre doble cierre de seguridad sin accesorios.

Single lever WC Magnet with double closing safety lock without accessories..

Cartucho Cartridge: 25000-2



PME01

AAZ302651

Placa necesaria para montaje en pladur.
Plate needed for mounting in plasterboard.



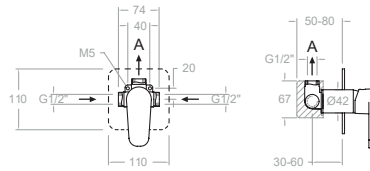

364502

36F308298
361801S+3796+9560+247903C

364502NM

36F308300
361801SNM+3796NM+9560NM+1121CNM

364502NC

36F308299
361801SNC+3796NC+9560NC+1121CNC

364502OC

36F308301
361801SOC+3796OC+9560OC+1121COC

Monomando empotrado de WC con duchita.
Single lever WC with shower.

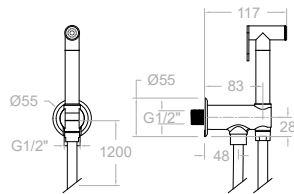

114604WC

99F308833
379802+9552+1120CHP

114604WCNM

99F308834
379802NM+9552NM+1121CNM

114604WCOC

99F308835
379802OC+9552OC+1121COC

Conjunto de duchita para WC de una agua.
Shower set for single water WC.



Disponible en Julio
Available in July

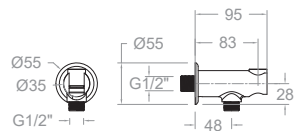

379802

99Z308830

379802NM

99Z308831

379802OC

99Z308832

Llave de paso con cierre automático.
Angle valve with automatic stop.

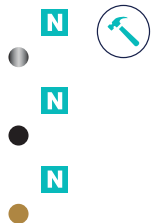

Disponible en Julio
Available in July

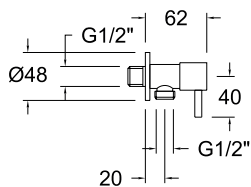

3797
230514

3797NM
99Z306002

3797NC
99Z308649

3797OC
99Z308648

3797CUC
99Z308650

Llave de paso cerámica de 1/2".
1/2" ceramic angle valve.

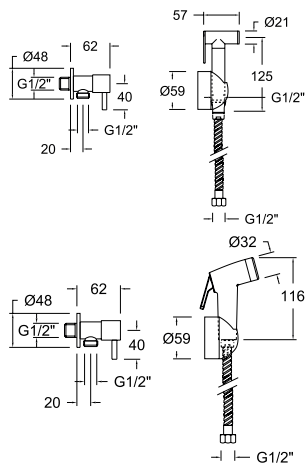
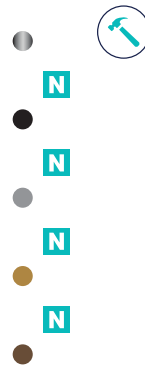

114102

99F301561
3797-9552+354802+247903C

Conjunto para WC con duchita de latón.
WC set with brass shattaf.

114202

99F301562
3797-955102+354802+247902C

Conjunto para WC con duchita de ABS.
WC set with ABS shattaf.

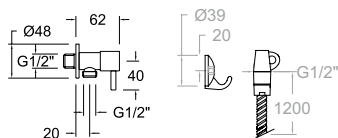
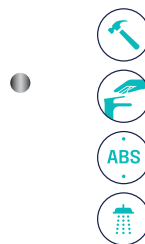

114702

99F301563
3797-3799+247902C

Conjunto para WC.
WC set.

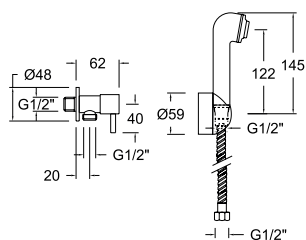
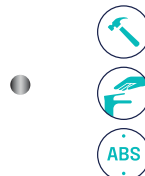

114902

99F301565
3797-9553+354802+247902C

Conjunto para WC.
WC set.



WC

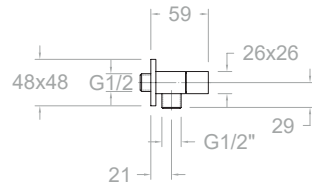

4797
242304

Llave de paso cerámica de 1/2".
Ceramic angle valve 1/2" ..

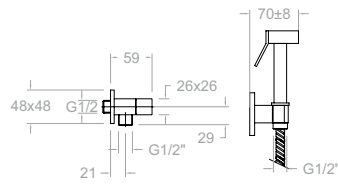

411902

99F301571
4797+4552+4741+247903C

Conjunto para WC.
WC set.

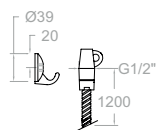
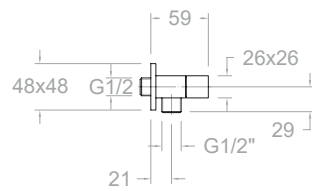

411702

99F301569
4797+3799+247903C

Conjunto para WC.
WC set.



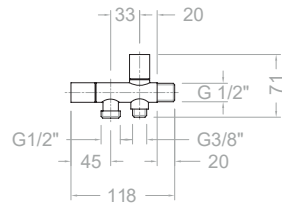

3793

99Z303339

Llave de paso cerámica con dos salidas (cisterna WC+ duchita WC).

Ceramic angle valve with 2 outlets (WC tank + shattaf).



3795

300150

Llave de paso cerámica con dos salidas (cisterna WC+ duchita WC).

Ceramic angle valve with 2 outlets (WC tank + shattaf).

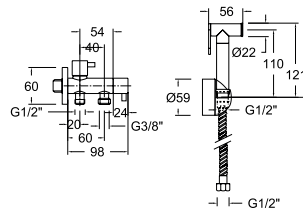

113702

99F301567

3793+9552+354802+247903C

Conjunto de WC para duchita y cisterna de WC.

WC set for shattaf and WC tank.



WC

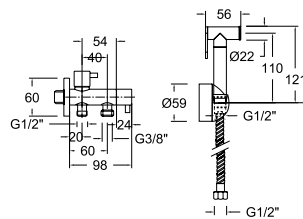

113502

99F301566

3793+955102+354802+247902C

Conjunto de WC para duchita y cisterna de WC.

WC set for shattaf and WC tank.



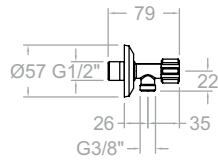

1288
AAZ301266

Llave de paso de 1/2" y 3/8".
Standard angle valve 1/2" and 3/8".

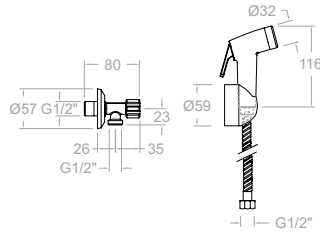

115601
99F301558

1289-955102+354802+247902C

Conjunto para WC.
WC set.

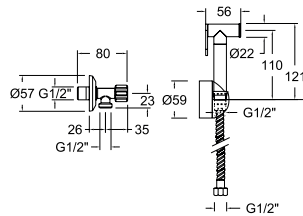

115701
99F301559

1289-9552+354802+247903C

Conjunto para WC.
WC set.

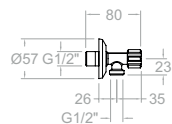

115801
99F301560

1289-3799+247902C

Conjunto para WC.
WC set.

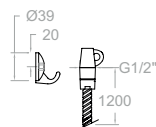

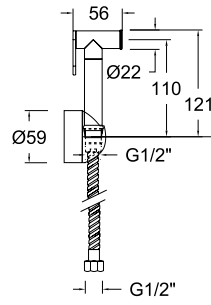

115202

99F301574

95512+354802+247903C

Conjunto WC sin llave de paso.
WC set without angle valve.

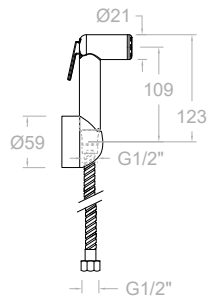

115102

99F301572

955102+354802+247902C

Conjunto WC sin llave de paso.
WC set without angle valve.



WC

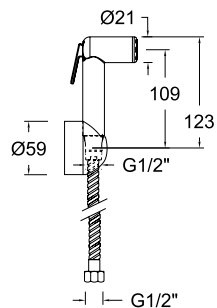

115103

99F303323

955102+354802+1122CHP

Conjunto WC sin llave de paso.
WC set without angle valve.



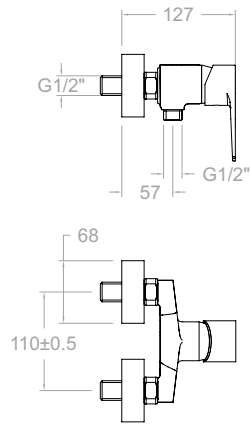

1843S
18F301575
XX43+1800-35

Monomando mural para WC.
Single lever mixer for WC.

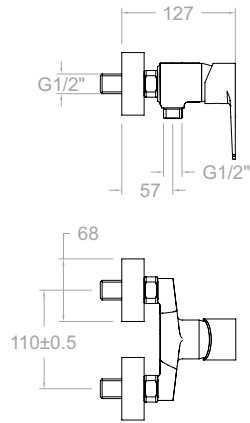

3643S
36F301692
XX43+3600-35

Monomando mural para WC.
Single lever mixer for WC.

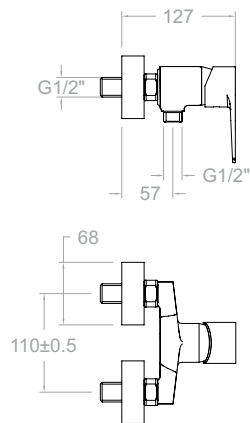

3343S
33F301581
XX43+3300-35

Monomando mural para WC.
Single lever mixer for WC.



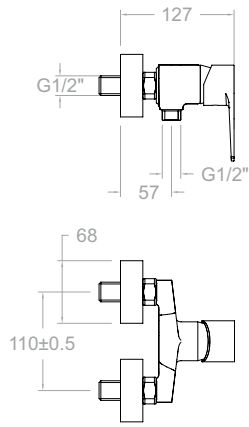

6443S
64F301580
XX43-6400-35

Monomando mural para WC.
Single lever mixer for WC.



574301S
57F304992
XX43-5700-35

Monomando mural para WC.
Single lever mixer for WC.



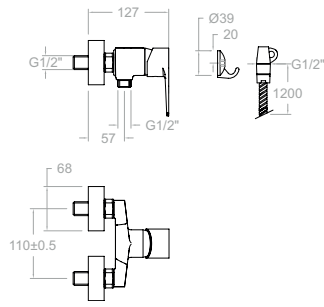

1843WC

99F300597

1843S+3799+247902C

Monomando mural para WC con accesorios de ABS.
Single lever wall mounted WC mixer with ABS accessories.



3643WC

36F301693

3643S+3799+247902C

Monomando mural para WC con accesorios de ABS.
Single lever wall mounted WC mixer with ABS accessories.



334302WC

33F301342

3343S+3799+247902C

Monomando mural para WC con accesorios de ABS.
Single lever wall mounted WC mixer with ABS accessories.



6443WC

99F300600

6443S+3799+247902C

Monomando mural para WC con accesorios de ABS.
Single lever wall mounted WC mixer with ABS accessories.



574301WC

57F304993

574301S+3799+247902C

Monomando mural para WC con accesorios de ABS.
Single lever wall mounted WC mixer with ABS accessories.

Cartucho Cartridge: 35000-3

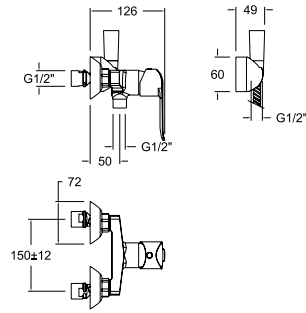
**184403WC**

18F305170

1843S+9559+354802+247902C

Monomando mural para WC con ducha de metal.
Single lever mixer 110 mm with shattaf set.

**364403WC**

36F305172

3643S+9559+354802+247902C

Monomando mural para WC con ducha de metal.
Single lever mixer 110 mm with shattaf set.

**334403WC**

33F305171

3343S+9559+354802+247903C

Monomando mural para WC con ducha de metal.
Single lever mixer 110 mm with shattaf set.

**644403WC**

64F305174

6443S+9559+354802+247902C

Monomando mural para WC con ducha de metal.
Single lever mixer 110 mm with shattaf set.

**574403WC**

57F305173

574301S+9559+354802+247902C

Monomando mural para WC con ducha de metal.
Single lever mixer 110 mm with shattaf set.

Cartucho Cartridge: 35000-3

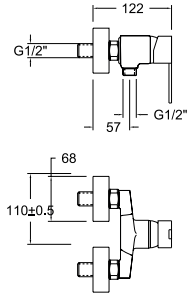

4943S

49F301576

XX43+1329+4900-35

Monomando mural para WC.
Single lever wall mounted WC mixer.

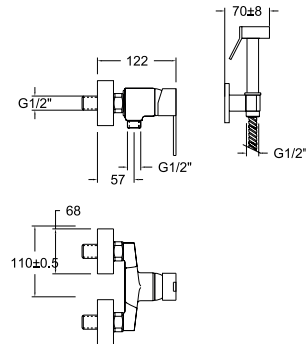

4944WC

99F300800

4943S+4552+4741+247903C

Monomando mural para WC con accesorios.
Single lever wall mounted WC mixer with accessories.



Cartucho Cartridge: 252978

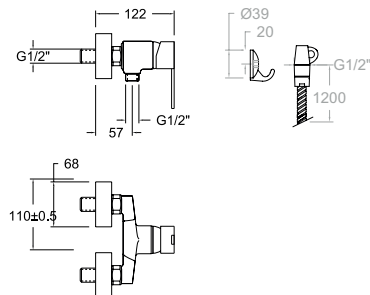

4943WC

99F300602

4943S+3799+247903C

Monomando mural para WC con accesorios.
Single lever wall mounted WC mixer with accessories.



Cartucho Cartridge: 252978



1121CNM
99Z302172



1121CNC
99Z302323



1121COC
99Z302324



Flexible 1,2 m.
High pressure flexible hose 1,2 m.



1120CHP
AAZ301305



Flexible de alta presión para Wc 1,2 m.
High pressure flexible hose for shataff 1,2 m.

1122CHP
AAZ302809



Flexible de alta presión para Wc 1 m.
High pressure flexible hose for shataff 1 m.



247902C
99Z305409



Flexible de alta presión para Wc 1 m.
High pressure flexible hose for Wc 1 m.



247903C
99Z307905



Flexible de alta presión para Wc 1,2 m.
High pressure flexible hose for shataff 1,2 m.



3796
227490



3796NM
99Z302357



3796NC
99Z302356



3796OC
99Z302358



3796CUC
99Z307678



Codo de salida de agua y soporte fijo.
Metallic water outlet with handshower support.



354802
99Z302082



354802NM
99Z309136



354802NC
99Z309025



354802OC
99Z309026



354802CUC
99Z309027



Soporte de pared para ducha.
Shower support.



4727
99Z309456



4727NM
99Z309458



4727NC
99Z309460



4727OC
99Z309459



4727CUC
99Z309461



Soporte de ABS de pared para ducha.
ABS shower wall support.



4741
300152



4741NM
99Z306003



Soporte metálico de pared para ducha.
Metal shower wall support.



9560
99Z308292

9560NM
99Z308294

9560NC
99Z308297

9560OC
99Z308295



Ducha de mano de 1 agua para WC.
1-water hand shower for WC.



9552
230037

9552NM
99Z304159

9552NC
99Z304161

9552OC
99Z304160



Ducha de latón de mano para WC.
Brass shataff for WC.



9553
199833

Ducha de mano para WC.
Handshower for WC.



4552
300151

Ducha de mano para WC.
Handshower for WC.



955102
99Z304035

Ducha de mano para WC.
Handshower for WC.



3799
240621

Director de chorro M1/2.
Chrome spray shower M1/2.



9559
99Z304408

Ducha de mano para WC de latón.
Brass WC hand shower.





WC

Cocinas Kitchen







Campo magnético
Magnetic field



Colocación y extracción
sin esfuerzo se
autoposiciona por el
campo magnético.

Maneta agua filtrada
Handle filtered water

Salida agua filtrada
Filtered water output

Control monomando
Single-lever control

898801MC
38E306084

898801MCNM
38E306085

898801MCNC
38E306086

Kitchen Pure Water, monomando de cocina profesional con
circuitro para agua purificada.
Kitchen Pure Water, professional kitchen single-lever mixer with
circuit for purified water.

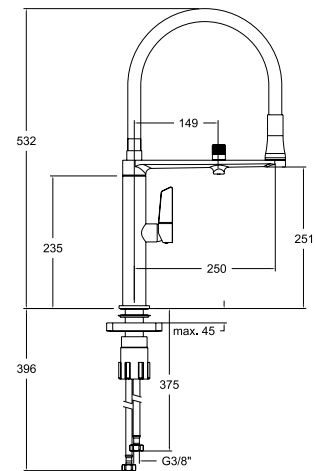

Cartucho Cartridge: 25000-2 + 8991

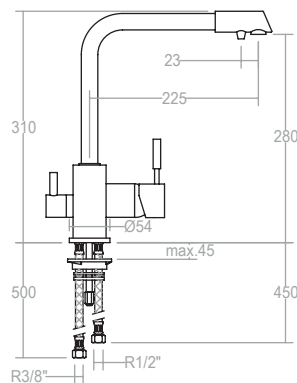

7589
255336

Monomando de cocina con caño alto giratorio y circuito para
agua purificada.
Kitchen single-lever mixer with high swivel spout and purified
water circuit.

Montura Mount: AAZ302090

3785
220101

Sistema de filtro con carbono activo.
Filter system with activated carbon.

3786
220110

Cartucho de filtro de carbono activo para grifo de agua
purificada.
Cartridge of activated carbon filter for purified water faucet.

Cartucho Cartridge: 35000 (3750) + 3791



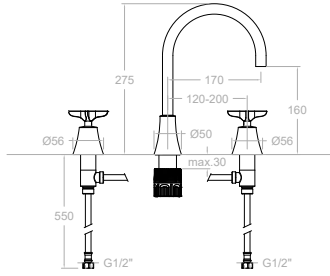

914901
91E309156

914901NM
91E309157

914901OC
91E309158

914901GR
91E309159

Adagio, fregadero de repisa con caño giratorio de 170mm.
Adagio, shelf sink with 170mm swivel spout.

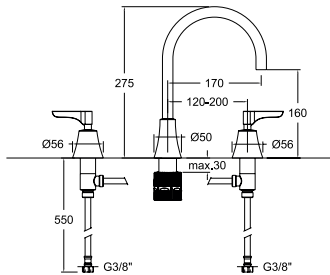
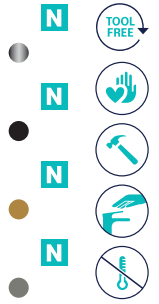

914901ML
91E309160

914901MLNM
91E309161

914901MLOC
91E309162

914901MLGR
91E309163

Adagio, fregadero de repisa con caño giratorio de 170mm.
Adagio, shelf sink with 170mm swivel spout.

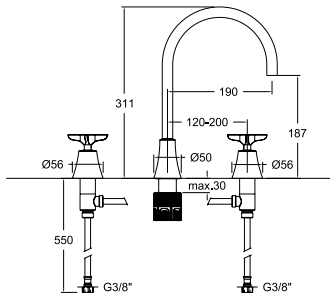
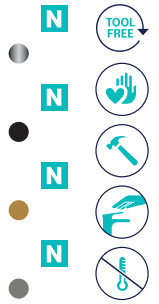

914902
91E309164

914902NM
91E308072

914902OC
91E308198

914902GR
91E308199

Adagio, fregadero de repisa con caño giratorio de 190mm.
Adagio, shelf sink with 190mm swivel spout.

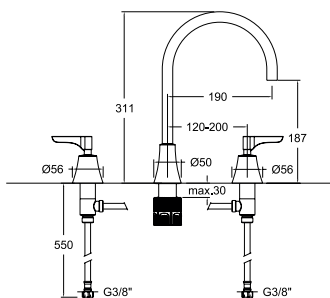
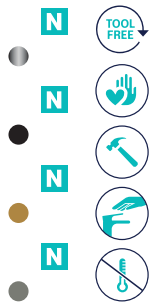

914902ML
91E308200

914902MLNM
91E309060

914902MLOC
91E309063

914902MLGR
91E309098

Adagio, fregadero de repisa con caño giratorio de 190mm.
Adagio, shelf sink with 190mm swivel spout.

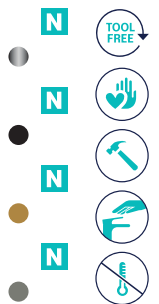

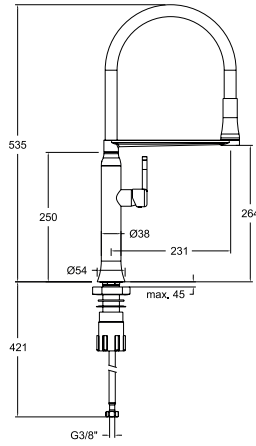

386801MA
38E303484

386801MACU
38E304205

Monomando de cocina, giratorio y extraíble con sistema de imanes.
Kitchen single-lever mixer, swivel and extractable with magnet system.



Cartucho Cartridge: 25000-2

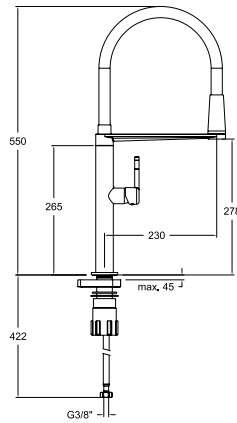

388801MA
38E303469

388801MACU
38E305118

Monomando de cocina, giratorio y extraíble con sistema de imanes.
Kitchen single-lever mixer, swivel and extractable with magnet system.



Cartucho Cartridge: 25000-2

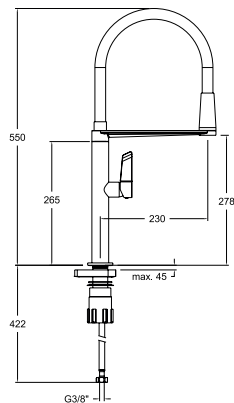

388801MC
38E303421

388801MCNM
38E303481

388801MCNC
38E304206

Monomando de cocina, giratorio y extraíble con sistema de imanes.
Kitchen single-lever mixer, swivel and extractable with magnet system.



Cartucho Cartridge: 25000-2

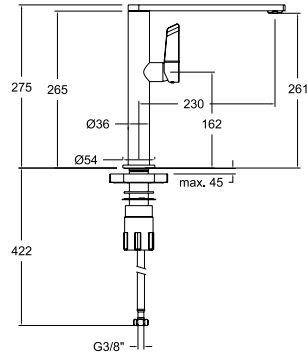

388401MC
38E303408

388401MCNM
38E303420

388401MCNC
38E303600

Monomando de cocina con caño alto giratorio.
Kitchen single-lever mixer with high swivel spout.

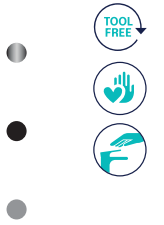

Cartucho Cartridge: 25000-2

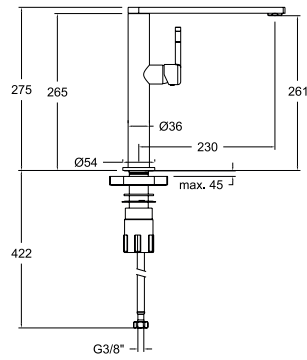

388401MA
38E303410

388401MACU
38E305119

Monomando de cocina con caño alto giratorio.
Kitchen single-lever mixer with high swivel spout.

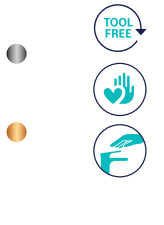

Cartucho Cartridge: 25000-2





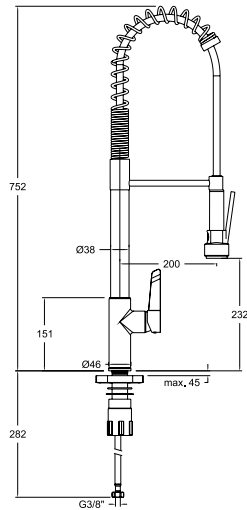

386701MC
38E303480

Monomando de cocina profesional, altura 752mm.
Professional kitchen single-lever mixer, height 752mm.



Cartucho Cartridge: 35100 (6689-2)

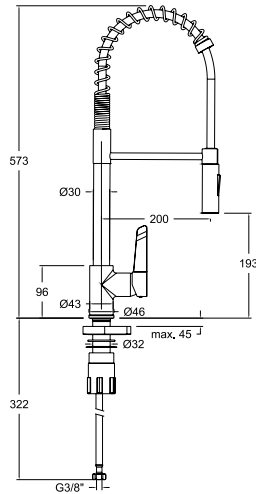

386601MC
38E303479

Monomando de cocina profesional, altura 573mm.
Professional kitchen single-lever mixer, height 573mm.



Cartucho Cartridge: 35100 (6689-2)

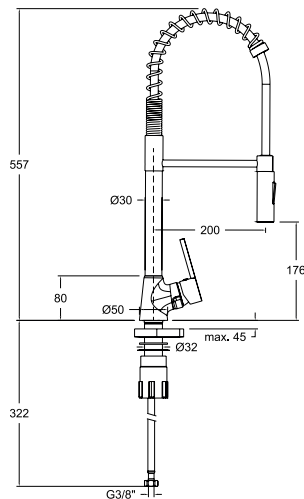

386501MD
38E303603

Monomando de cocina profesional, altura 557mm.
Professional kitchen single-lever mixer, height 557mm.



Cartucho Cartridge: 35100 (6689-2)

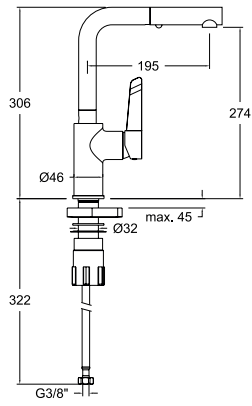

381901H1MC

38E304202

Monomando de cocina con ducha metálica y 2 jets extraíbles.
Kitchen single-lever mixer with metallic shower and 2 extractable jets.



Cartucho Cartridge: 35100-2

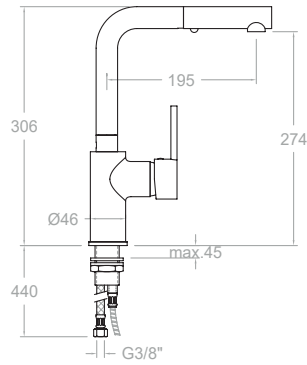

331902H1

33E301600

Monomando de cocina con ducha metálica y 2 jets extraíbles.
Kitchen single-lever mixer with metallic shower and 2 extractable jets.

Cartucho Cartridge: 35100-2

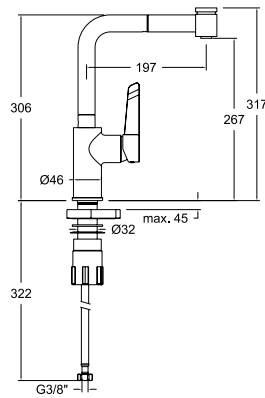

381901H2MC

38E304203

Monomando de cocina con ducha y 2 jets extraíbles.
Kitchen single-lever mixer with shower and 2 extractable jets.



Cartucho Cartridge: 35100-2

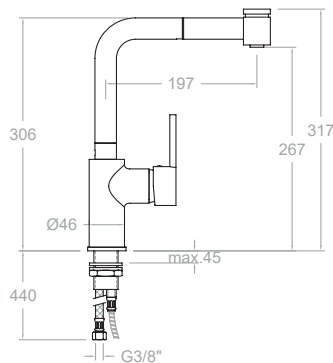

331902H2

33E301601

Monomando de cocina con ducha y 2 jets extraíbles.
Kitchen single-lever mixer with shower and 2 extractable jets.

Cartucho Cartridge: 35100-2

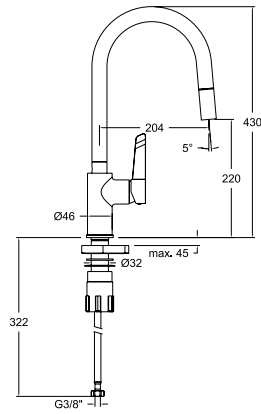

387901V1MC
38E304200

Monomando de cocina con caño alto metálico y 2 jets extraíbles, minimalista.
Kitchen single-lever mixer, metallic high spout with 2 extractable jets, minimalist.

Cartucho Cartridge: 35100-2

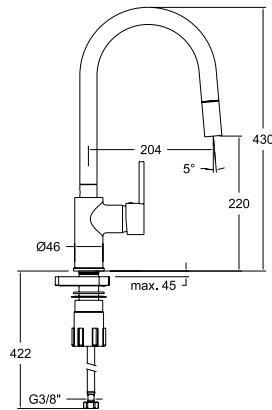

337902V1
33E301598

Monomando de cocina, caño alto metálico con 2 jets extraíbles.
Kitchen single-lever mixer, metallic high spout with 2 extractable jets.

Cartucho Cartridge: 35100-2

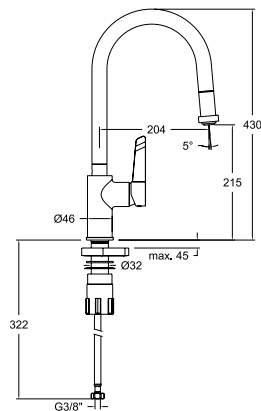

387901V2MC
38E304201

Monomando de cocina con caño alto metálico y 2 jets extraíbles.
Kitchen single-lever mixer, metallic high spout with 2 extractable jets.

Cartucho Cartridge: 35100-2

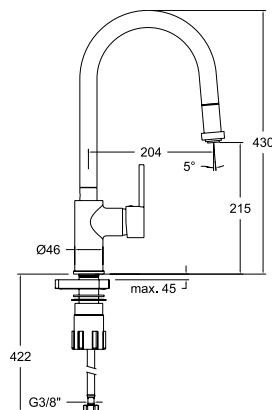

337902V2
33E301599

Monomando de cocina, caño alto metálico con 2 jets extraíbles.
Kitchen single-lever mixer, metallic high spout with 2 extractable jets.

Cartucho Cartridge: 35100-2

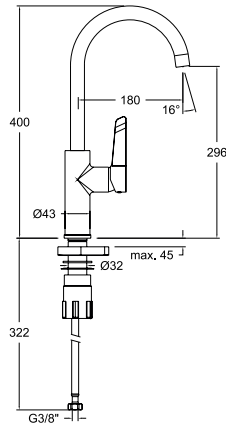

380602MC
38E304233

Monomando de cocina con caño giratorio.
Kitchen single-lever mixer with swivel spout.



Cartucho Cartridge: 35100 (6689-2)



330602
33E301596

330602NM
33E306168

330602CUC
33E305120

Monomando de cocina con caño giratorio.
Kitchen single-lever mixer with swivel spout.



Cartucho Cartridge: 35100 (6689-2)

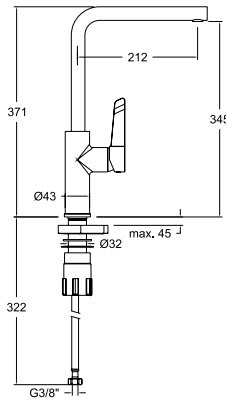

382902MC
38E304204

Monomando de cocina con caño giratorio.
Kitchen single-lever mixer with swivel spout.



Cartucho Cartridge: 35100 (6689-2)



332902
33E301602

332902NM
33E306169

332902CUC
33E305121

Monomando de cocina con caño alto giratorio.
Kitchen single-lever mixer with high swivel spout.



Cartucho Cartridge: 35100 (6689-2)



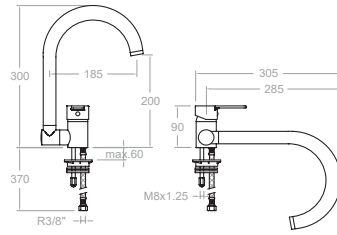

9369
227346

Monomando de fregadero con caño abatible.
Sink mixer with swivel and folding spout.



Cartucho Cartridge: 40100-2 (3388-2)

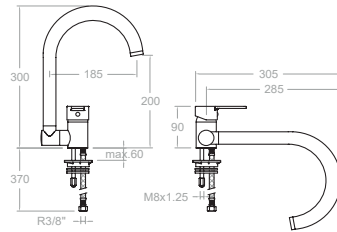

3369
221676

Drako, monomando de fregadero con caño abatible.
Drako, single-lever sink mixer with swivel spout..



Cartucho Cartridge: 40100-2 (3388-2)

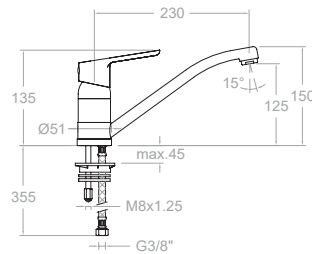

1809
18E300516

Titanium, monomando de fregadero con caño bajo giratorio.
Titanium, single lever sink tap with cart spout.



Cartucho Cartridge: 40200-2 (3388-2 K C2)

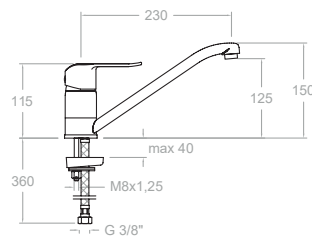

6499
261762

Ypsilon Plus, monomando de fregadero con caño bajo giratorio y sistema de apertura en agua fría.
Ypsilon Plus, sink mixer with low swivel spout and cold water opening system.



Cartucho Cartridge: 40300-2 (3388-2 K C3)

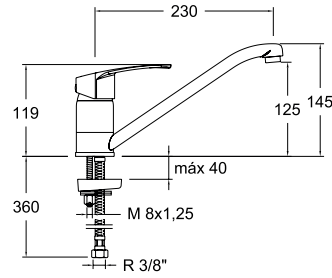

579901
57E303578

New Fly, monomando de fregadero con caño bajo giratorio.
New Fly, sink single-lever mixer with low swivel spout.



Cartucho Cartridge: 40300-2 (3388-2 K C3)

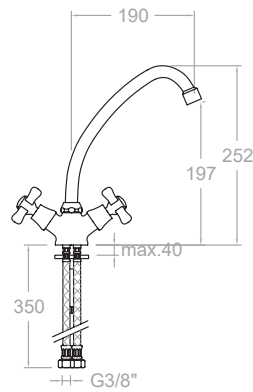

3109C
261867

Gaudí, bimando de fregadero con caño giratorio altura L.
Gaudí, sink dual-handle with swivel spout, height L.



Montura Head: 1700C 1/2"

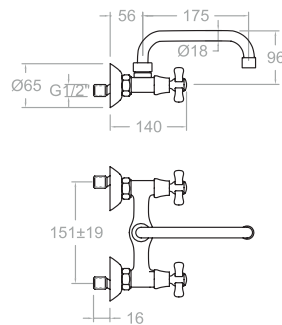

3117C
300156

Gaudí, bimando de fregadero mural con caño giratorio.
Gaudí, wall-mounted kitchen dual-handle with swivel spout.



Montura Head: 1700C 1/2"

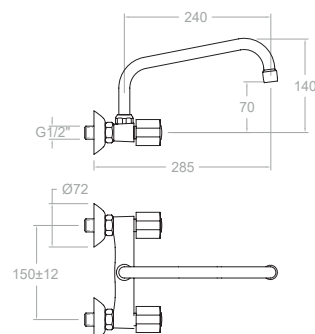

7009CAI30E4
803287

Eco, bimando de fregadero mural con caño largo superior inclinado giratorio.
Eco, wall-mounted sink mixer with upper inclined swivel spout..



Montura Head: 5000

Breeam · Hoteles
Breeam · Hotels

Proyectos en todo el mundo

Projects around the world

Las griferías y duchas de **ramonsoler** han sido certificadas con las normativas más exigentes y sus redes comerciales se extienden a más de 40 países. Con numerosas referencias hoteleras internacionales, la firma está presente en cadenas hoteleras.

Millones de usuarios utilizan diariamente nuestros productos, renovando día a día su confianza. **ramonsoler** se encuentran en las instalaciones más importantes: cadenas hoteleras internacionales, grandes hospitales, transatlánticos, grandes yates, hoteles con encanto, promociones de prestigio e incluso en promociones pioneras y sensibles al ahorro de agua y al medio ambiente.

The faucets and showers of **ramonsoler** have been certified with the most restrictive standards and its commercial networks span more than 40 countries. With numerous International hotel references, the firm is present in hotel chains.

Millions of consumers use our products every day, constantly confirming their confidence in us. **ramonsoler** systems can be found at countless leading establishments: international hotel chains, large hospitals, ocean liners, super yachts, hotels with charm and even pioneering ecofriendly developments where water saving systems are installed.



SHERATON AIRPORT
Frankfurt (Germany)

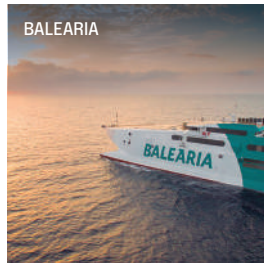

BALEARIA



POLICE HEADQUARTERS
Frankfurt (Germany)

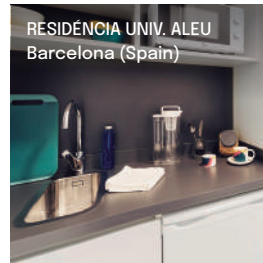

RESIDENCIA UNIV. ALEU
Barcelona (Spain)



HOSPITAL ALGARVE
Algarve (Portugal)

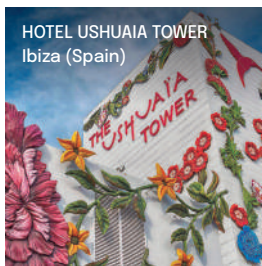

HOTEL USHUAIA TOWER
Ibiza (Spain)



HOTEL INTERCONTINENTAL
Tahiti (Polynesia)



HOTEL FERGUS
Conil de la frontera (Spain)

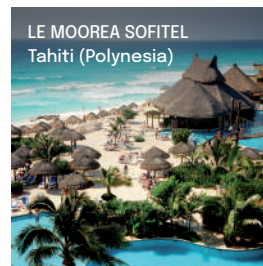

LE MOOREA SOFITEL
Tahiti (Polynesia)

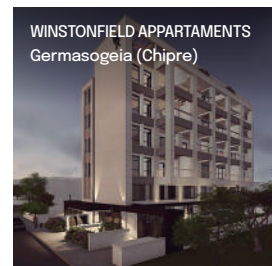

WINSTONFIELD APPARTAMENTS
Germasogeia (Chipre)



HARD ROCK CAFE
Ibiza (Spain)



WALDORF ASTORIA
Dubai

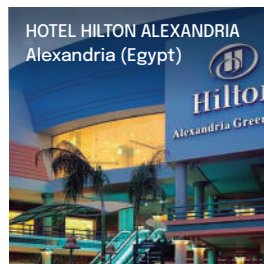

HOTEL HILTON ALEXANDRIA
Alexandria (Egypt)

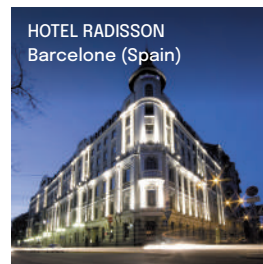

HOTEL RADISSON
Barcelone (Spain)



BAWABAT ALSHARQ
Abu Dhabi (UAE)



HOTEL 2122
Punta del Este



GRAND PALLADIUM
Lucea (Jamaica)



MARRIOT LOS SUEÑOS
Costa Rica

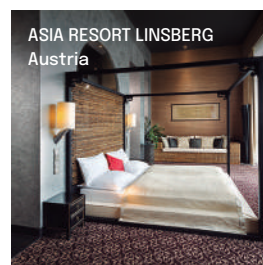

ASIA RESORT LINSBERG
Austria



LE STADE DES LUMIÈRES
Lyon (France)



DIAGONAL 640
Barcelona (Spain)

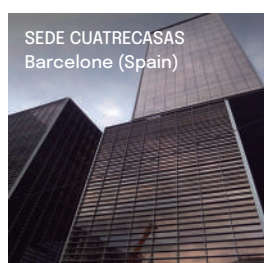

SEDE CUATRECASAS
Barcelone (Spain)

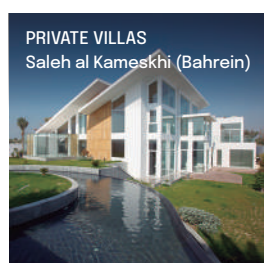

PRIVATE VILLAS
Saleh al Kameskhi (Bahrein)



SERENADE PUNTA CANA
República Dominicana

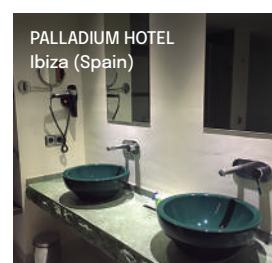

PALLADIUM HOTEL
Ibiza (Spain)

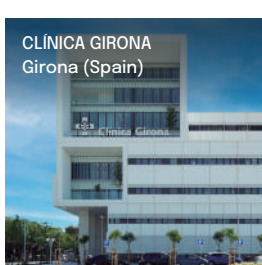

CLÍNICA GIRONA
Girona (Spain)

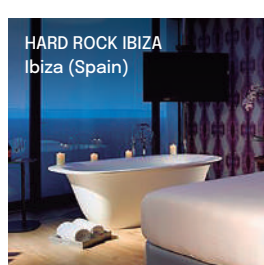

HARD ROCK IBIZA
Ibiza (Spain)

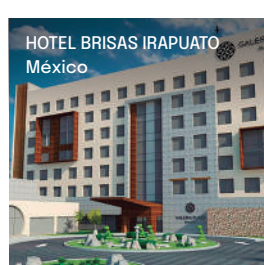

HOTEL BRISAS IRAPUATO
México

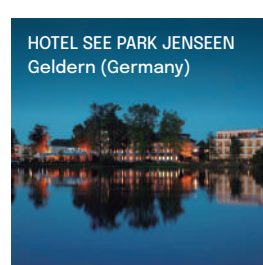

HOTEL SEE PARK JENSEN
Geldern (Germany)

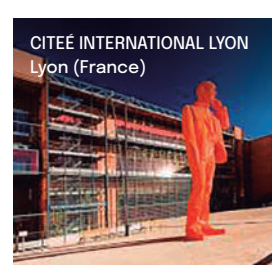

CITÉE INTERNATIONALE LYON
Lyon (France)

Grifería exclusiva para hoteles

Exclusive tapware for hotels



ramonsoler es uno de los principales suministradores de la industria hotelera, que desde hace más de 25 años se supera día a día perfeccionando sus productos para sus específicas exigencias, tanto en ahorro de agua, como en seguridad, salud y pleno confort para las personas. Una buena grifería para HOTEL tiene que presentar no solo una estética depurada y de diseño, sino que también es necesario que reúna un conjunto de características técnicas que hagan de todo el conjunto una pieza idónea para proyectos del sector hotelero.

Las griferías de **ramonsoler** especialmente diseñadas para HOTELES están cuidadosamente creadas con una gran cantidad de ventajas, que beneficiarán tanto al huésped como al propietario del HOTEL.

ramonsoler is one of the foremost suppliers of tapware for the hotel industry. For more than 25 years the daily needs of these clients have been covered, including water saving, security, health and comfort for the hotel guests. A good hotel tapware not only enhances the aesthetic quality of the room but must also have a number of technical characteristics which make it ideal for this type of use.

ramonsoler brassware has been especially designed for Hotels and takes into account the needs of both the guest and hotel chain.





SERENADE BEACH&SPA RESORT
PUNTA CANA

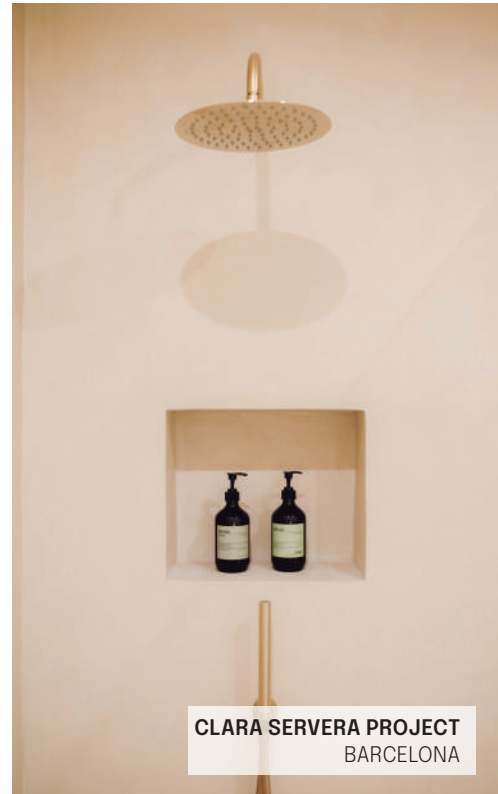

CLARA SERVERA PROJECT
BARCELONA



WALDORF ASTORIA
DUBAI



HOTEL PEDRO I ARAGÓN
HUESCA



NEVA TOWERS
MOSCÚ



HOUSE BY SCENA INTERIORDESIGN
ALEMANIA



Hotel Premium

Premium hotel

Momentos de relajación y confort entre altas dosis de diseño y espectacularidad. El Hotel Premium ha sido ideado para los clientes con gusto urbano y cosmopolita. Destaca por su amplio catálogo de series que aúnan diseño, calidad y tecnología.

Además, ofrece diseño sostenible en sus series de alta gama que han sido creadas bajo un principio de consumo responsable e integran sistemas de ahorro de agua y limitadores de caudal en sus componentes internos.

Moments of relaxation and comfort between high doses of design and beauty. Our premium series have been designed for customers with urban and cosmopolitan taste, and **ramonsoler** stands out for its wide range of series that combine design, quality and technology.

It offers sustainable design in its high-end series, which have been created under a principle of responsible water consumption and integration of water-saving systems in its internal components.



Adagio



Urban Chic



Alexia



Tzar



Hotel con encanto

Charming hotel

Cuando el cuidado por cada detalle y la calidad se encuentran en un hotel, su encanto es indiscutible. Encontrar elegancia y despertar sensaciones de serenidad en un hotel con encanto es un hecho, por su puesta en escena, su estilo sutil y su marcado carácter.

The beauty of a hotel is defined by its detail and features. A hotelier not only sells a room, but a series of sensations which clients look forward to, and these expectations must be fulfilled with a complete wellness programme.



Gaudí

Hotel Medium

Medium hotel



Drako

New fly

Ypsilon Plus

Las líneas básicas y el cuidado por el medio ambiente se respiran en el hotel MEDIUM. **ramonsoler** ofrece para estos espacios series de líneas sencillas que no renuncian a la calidad, completándolos con el carácter ecofriendly y económico que los caracterizan. Con **ramonsoler**, el hotel MEDIUM se viste de modernidad y funcionalidad

MEDIUM HOTEL are **ramonsoler** basic lines, designed with simple lines bringing high quality, environmentally friendly and economic mixers for all the hotel industry. With **ramonsoler**, MEDIUM hotel brings to the hotels modernity and functionality.

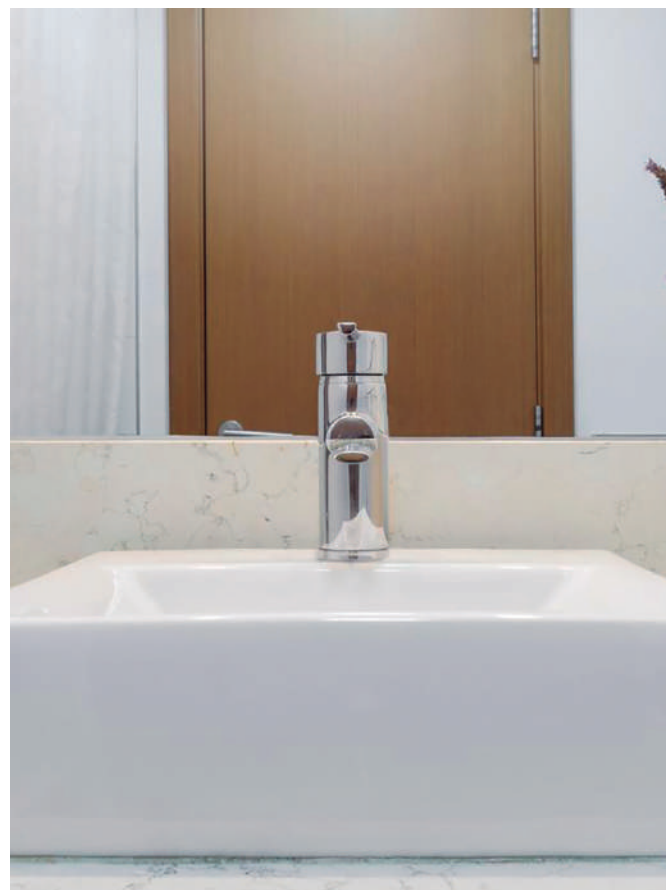

Servicio y estudios personalizados de ahorro para hoteles

Personalised hotel water efficiency studies

- Asesoramiento Técnico Pre-Venta. A petición del establecimiento hotelero nuestro equipo de análisis y estudios realizará un plan de gestión global para minimizar los costes en el suministro de agua.
- Servicio Post Venta y Calidad. La calidad de **ramonsoler** va mucho más allá del ciclo de vida de un producto, cuando ese producto deja de fabricarse, sus recambios permanecen disponibles durante un periodo de diez años.
- Ofrecemos anualmente más de 2.000 productos que cumplen con los estándares de calidad y las normativas europeas más exigentes.

- We offer the possibility of evaluating the water use and saving which can be undertaken by implementing our systems in any hotel.
- Pre-sales and Post sales service and quality control.
- We currently offer more than 2.000 products which comply with the highest european quality standards.
- **ramonsoler** quality exceeds the life cycle of the product, as we maintain a ten year stock in spare parts.

Cálculo Hotel

Calculation

Cálculo ocupación media hoteles 175 habitaciones.
Calculation average hotel occupancy 175 rooms.

• HOTEL	
Datos usuario User data	Variables
Ocupación media (pax) Average occupancy (pax)	175
Características grifería Fittings features	Variables
Consumo lavado standard Standard wash consumption	10,00 L/min
Consumo ducha standard Standard shower consumption	15,00 L/min
Consumo lavado RS versión Hotel Sistema S2-C2 Consumption washing RS Hotel version S2-C2 System	3,75L/min
Consumo lavado RS versión Hotel Sistema C3 Consumption washing RS Hotel version C3 System	3,75L/min
Consumo ducha RS versión Hotel Sistema S2-C2 Shower consumption RS Hotel version S2-C2 System	6,00 L/min
Hipótesis Hypothesis	Variables
Tiempo ducha - media de uso Shower time - average use	7 minutos
Tiempo lavado/bidé - media uso Washing/bidet time - average use	3 minutos
Coste agua m3 - Zona - Valor medio estadístico Water cost m3 - average statistical value	1,39 €/m3
Coste kWh energía - Zona - Valor medio estadístico (Gas) kWh energy cost - statistical average value (Gas)	0,053 €/KWh
Resultado Results	Variables
Coste agua Cost of water	0,0014 €/L
Coste energía por litro agua caliente Energy cost per litre hot water	0,0033 €/L
Coste Energía + Agua Energy + Water Cost	0,0046 €/L
Coef. Usos K - según NF P 40-202 - DTU 60.11(*) Usage Coef. K - according to NF P 40-202 - DTU 60.11(*)	0,22
Consumo instantaneo Grifería estandar Instantaneous consumption Standard fittings	1222 L/min
Consumo instantaneo Grifería ramonsoler versión Hotel Instantaneous consumption faucet Hotel version	574 L/min
Consumo Grifería estandar Consumption Standard faucet	23.625L/día
Consumo Grifería ramonsoler Consumption ramonsoler faucet	11,769 L / día
Ahorro con Sistema S2-C2 ramonsoler Savings with S2-C2 ramonsoler System	-11,856 L / día
Ahorro con Sistema S2-C2 ramonsoler Savings with S2-C2 ramonsoler System	-50,2%
Ahorro medio energía [kWh/h/año] - norma UNE 94002:2005 Average energy savings [kWh/h/year] - UNE 94002:2005 Standard	-265.761 kWh/año
Ahorro económico lavado y ducha sistema S2-C2 S2-C2 economic saving in washbasin and shower system	-20.101 €/año
Ahorro económico lavado C3 y ducha S2-C2 Economical saving C3 basin and S2-C2 shower	-25.485 €/año

Los grifos deben cumplir las siguientes características funcionales

Mixers & Standards

La grifería sanitaria de **ramonsoler** cumple con la más estricta normativa europea del sector, sobre la que realizamos ensayos en nuestros laboratorios que se encuentran técnicamente preparados para ello:

Los grifos o mezcladores mecánicos se ensayan conforme a la norma UNE-EN817:2009 y a la norma UNE 19703:2016.

Los grifos simples y los mezcladores cumplen con la norma UNE-EN 200:2008

Los materiales en contacto con el agua no han de constituir ningún peligro para la salud a una temperatura de 90°C. No deben producir alteración alguna en el agua a nivel cualitativo, de aspecto, de olor o del gusto. Los materiales susceptibles a la corrosión serán tratados para evitarla.

Los revestimientos y las superficies significativas de los productos deben cumplir la norma UNE-EN 248:2003.

Reguladores de chorro, conexiones flexibles, flexibles de ducha, mangos de ducha y rociadores, válvulas,... todos los productos pasan por un proceso de homologación interna en base a la normativa europea aplicable, garantizando tanto los niveles de calidad como la intercambiabilidad de los mismos.

ramonsoler complies with the strictest European Standards in the sector. Our Quality Lab is technically prepared to conduct tests according such standards:

• **ramonsoler** complies with the strictest European Standards in the sector. Our Quality Lab is technically prepared to conduct tests according such standards:

- Mixers are tested in accordance with UNE-EN817: 2009
- Mixers are tested in accordance with UNE-EN 200: 2008
- Materials in contact with water must not constitute a health hazard at a temperature of 90°C. They should not produce any alteration in water quality level, appearance, odor or taste. The materials used by **ramonsoler** are hazardous free.

• Chromate process is tested in accordance with UNE-EN 248: 2003.

• Regulators jet, flexible connections, flexible shower, shower handles and sprinklers, valves, ... all products go through a process of internal approval based on the applicable European regulations, guaranteeing both the levels of quality and interchangeability same.

Nuestro compromiso

Our engagement

ramonsoler, consciente de la importancia de la grifería no sólo en la higiene sino en el ahorro de agua y energía, se ha asociado con la organización European Water Label, con el objetivo de ofrecer una gama de productos eco eficientes, que respeten el medioambiente.

Todos los productos registrados en esta entidad se identifican con la siguiente etiqueta:

At **ramonsoler**, we are not only aware of the importance of the tapware in hygiene but also in water saving and energy issues. This in turn has enabled us to become associated with the European Water Label organization, with the aim of offering a range of eco-efficient products that respect the environment .

All these registered products are identified with the following label:

SIGNIFICADO DE LA ETIQUETA

Se muestra claramente el volumen máximo de agua, si el producto se ha instalado correctamente y de acuerdo con las instrucciones del fabricante

- Bandas de rendimiento de color
- La capacidad real / rendimiento



LABEL DEFINITION

It clearly shows the maximum volume of water if the product has been installed correctly and according to the manufacturer's instructions

- Coloured performance bands
- Actual capacity/performance

Características especiales

Special features

LAVABO

MIXER



LIMITADOR Anti-retorno
LIMITER Non-return

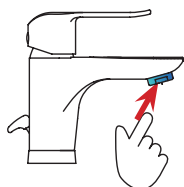

- Standard flow: 12 l/min.
- Flow limiter: 3,75 l/min
- SAVING: 68 %

1

Sistema de ahorro de agua y energía C2/S2 o C3/S3

Water & energy saving systems C2/S2 o C3/S3



C2/S2. Apertura en dos fases, con un tope intermedio para obtener un ahorro de agua del 50%.

C2/S2. Step two-phase opening, with an intermediate stop for saving 50% of water.



C3/S3. Apertura escalonada en frío. Ahorro de agua y energía.

C3/S3 Gradual opening cold. water and energy saving.

2

Aireadores. Limitadores de caudal

Aerators with flow limiter



Limitador de caudal de 3,5 l/min. Disponemos además de un amplio abanico de limitadores (1,7 l/min a 8 l/min.) adaptados a las necesidades del cliente.

Sistema de limitación NO removable, solo bajo control técnico.

Flow Limiter 3,5 l/min. We have also a wide range of limiters (1,7 l/min to 8 l/min) according our customer needs.

NON-removable limitation system, only under technical control.

3

Ánodo de sacrificio

Sacrificial anode



Protegemos de la corrosión las superficies de la grifería con un ánodo de sacrificio de zinc-magnesio el cual se coloca en todas nuestras series, tanto en los anclajes verticales como en los murales, asimismo nuestras manetas estan también protegidas. Este sistema patentado por **ramonsoler** triplica la vida de nuestros recubrimientos por corrosión externa.

In **ramonsoler** we protect the surfaces of the faucet from corrosion with a zinc-magnesium sacrificial anode which is placed in all our series, both in vertical anchors and murals, our handles are also protected. This system patented by **ramonsoler** triples the life of our external corrosion coatings.

OTRAS OPCIONES DE LIMITACIÓN DE CAUDAL

	REF	CAUDAL FLOW	AHORRO SAVING
Lavabos Mixers	1526 	8 L/min	33 %
	1517 	8 L/min	33 %
	1525 	8 L/min	50 %
	1528 	5 L/min	58 %
Standard	1527 	3,5 L/min	68 %
Spray	1529 	1,7 L/min	85 %

LAVABO
MIXER



LIMITADOR Anti-retorno
LIMITER Non-return

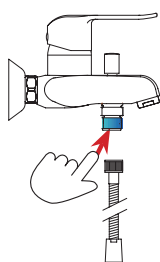

- Caudal standard: 15 l/min.
- Caudal reducido: 8l/min
- AHORRO: 45%
- Standard flow: 15 l/min.
- Flow limiter: 8l/min
- SAVING: 45 %

1 Sistema de ahorro de agua y energía S2
Water & energy saving systems S2



Ofrece una alta resistencia al uso frecuente y a los productos de limpieza.

Have this piece in order to get strength and durability.

2 Limitador caudal con antiretorno 6 l/min ARD+C6
Flow limited with antiretorno 6 l/min ARD+C6



Limitador de caudal de 6 l/min. Disponemos además de un amplio abanico de limitadores (3 l/min a 8 l/min.) adaptados a las necesidades del cliente.

Flow Limiter 6 L/min. We have also a wide range of limiters (3 l / min to 8 l / min) according our customer needs.

3 Distribuidor metálico
Metal diverter



Ofrece una alta resistencia al uso frecuente y a los productos de limpieza.

It is highly resistant to frequent use and cleaning products.

4 Anodo de sacrificio
Sacrificial anode



Protegemos de la corrosión las superficies de la grifería con un ánodo de sacrificio de zinc-magnesio el cual se coloca en todas nuestras series, tanto en los anclajes verticales como en los murales, asimismo nuestras manetas están también protegidas. Este sistema patentado por ramonsoler triplica la vida de nuestros recubrimientos por corrosión externa.

In ramonsoler we protect the surfaces of the faucet from corrosion with a zinc-magnesium sacrificial anode which is placed in all our series, both in vertical anchors and murals, our handles are also protected. This system patented by ramonsoler triples the life of our external corrosion coatings.

OTRAS OPCIONES DE LIMITACIÓN DE CAUDAL			
	REF	CAUDAL FLOW	AHORRO SAVING
Teleducha Handshower	JLC 10 	10 L/min	80 %
	JLC 8 	8 L/min	45 %
	JLC 6 	6 L/min	60 %
	JLC 3 	3 L/min	80 %
	ARD+C8 	8 L/min	45 %
Standard	ARD+C8 	8 L/min	60 %



BRE3602
36A305908

Caudal
Flow
5 l/min

BRE3602NM
36A305909

Caudal
Flow
5 l/min

BREH3602
36A306989

Caudal
Flow
3.5 l/min

BREH3602NM
36A306990

Caudal
Flow
3.5 l/min

Alexia Breeam, monomando de
lavabo XL.
Alexia Breeam, washbasin mixer XL.



BRE360302
36B306985

Caudal
Flow
5 l/min

BREH360302
36B306991

Caudal
Flow
3.5 l/min

Alexia Breeam, monomando de bidé.
Alexia Breeam, bidet mixer.



BRE3604
36A305904

Caudal
Flow
5 l/min

BRE3604NM
36A305905

Caudal
Flow
5 l/min

BREH3604
36A306992

Caudal
Flow
3.5 l/min

BREH3604NM
36A306995

Caudal
Flow
3.5 l/min

Alexia Breeam, monomando de
lavabo.
Alexia Breeam, washbasin mixer.



BRE360403
36A306986

Caudal
Flow
5 l/min

BRE360403NM
36A306987

Caudal
Flow
5 l/min

BREH360403
36A306993

Caudal
Flow
3.5 l/min

BREH360403NM
36A306994

Caudal
Flow
3.5 l/min

Alexia Breeam, monomando de
lavabo con apertura en frío.
Alexia Breeam, washbasin mixer, cold
opening.



BRE360602
36E305899

Caudal
Flow
5 l/min

Alexia Breeam, monomando de
fregadero.
Alexia Breeam, sink mixer.



BRE3605S
36C305903

Caudal
Flow
8 l/min

BRE360501SNM
36C305901

Caudal
Flow
8 l/min

BREH3605S
36C306999

Caudal
Flow
6 l/min

BREH360501SNM
36C306997

Caudal
Flow
6 l/min

Alexia Breeam, monomando de
baño-ducha.
Alexia Breeam, bath and shower mixer



BRE3605T1
36C305900
BRE3605S+3520T1+3726M+2472C

Caudal
Flow
8 l/min

BREH3605T1
36C307000
BREH3605S+3520T1+3726M+2472C

Caudal
Flow
6 l/min

Alexia Breeam, conjunto
monomando de baño-ducha con
equipo de ducha.
Alexia Breeam, bath and shower mixer
with shower set.



BRE3605BTNM
36C305902
BRE360501SNM+2876BTNM+
372602NM+2475CNM

Caudal
Flow
8 l/min

BREH360501BTNM
36C306998
BREH360501SNM+2876BTNM+
372602NM+2475CNM

Caudal
Flow
6 l/min

Alexia Breeam, conjunto
monomando de baño-ducha con
equipo de ducha.
Alexia Breeam, bath and shower mixer
with shower set



BRE3608S

36D305898

Caudal Flow 8l/min

BRE360801SNM

36D305895

Caudal Flow 8l/min

BREH3608S

36D307003

Caudal Flow 6l/min

BREH360801

36D307001

Caudal Flow 6l/min

Alexia Breeam, conjunto monomando de ducha sin equipo de ducha.

Alexia Breeam, shower mixer with shower set



BRE360801BTNM

36D305896

BRE360801SNM+2876BTNM+372602NM+2475CNM

Caudal Flow 8l/min

BREH360801BTNM

36D307002

BREH360801SNM+2876BTNM+372602NM+2475CNM

Caudal Flow 6l/min

Alexia Breeam, conjunto monomando de ducha con equipo de ducha.

Alexia Breeam, shower mixer with shower set



BRE3608T1

36D305897

BRE3608S+3520T1+3726M+2472C

Caudal Flow 8l/min

BREH3608T1

36D307004

BREH3608S+3520T1+3726M+2472C

Caudal Flow 6l/min

Alexia Breeam, conjunto monomando de ducha con equipo de ducha.

Alexia Breeam, shower mixer with shower set.



BRE362103

36A305893

Caudal Flow 5l/min

BRE362103NM

36A305894

Caudal Flow 5l/min

BREH362103

36A307005

Caudal Flow 3.5l/min

BREH362103NM

36A307007

Caudal Flow 3.5l/min

Alexia Breeam, monomando de lavabo empotrado mural con caño de 24 cm.

Alexia Breeam, wall washbasin mixer with 24 cm spout.



BRE363402TR

36D309679

BRE363402S+2877TR+3726M+2472C

Caudal Flow 8l/min

Alexia Breeam, termostático de baño- ducha, con equipo de ducha.

Alexia Breeam, thermostatic shower mixer, with shower set.



BRE363901TR

36C305889

BRE363901S+2877TR+3726M+2472C

Caudal Flow 8l/min

BREH363901TR

36C307011

BREH363901S+2877TR+3726M+2472C

Caudal Flow 6l/min

Alexia Breeam, termostático de baño- ducha, con equipo de ducha.

Alexia Breeam, thermostatic bath shower mixer, with shower set.



BRE363901S

36C305890

Caudal Flow 8l/min

BREH363901S

36C307010

Caudal Flow 6l/min

Alexia Breeam, termostático de baño- ducha salida cascada.

Alexia Breeam, thermostatic bath shower mixer with cascade spout.



BRE3304

33A307013

Caudal Flow 5l/min

BREH3304

33A307024

Caudal Flow 3.5l/min

Drako Breeam, monomando de lavabo.

Drako Breeam, single lever washbasin mixer.



BRE3304VA1169

33A307018

Caudal
Flow
5 l/min

BREH3304VA1169

33A307028

Caudal
Flow
3.5 l/min

Drako Breeam, monomando de lavabo, con válvula automática 1 1/4".
Drako Breeam, washbasin mixer with stainless steel pop-up waste 1 1/4".



BRE330403

33A307016

Caudal
Flow
5 l/min

BREH330403

33A307025

Caudal
Flow
3.5 l/min

Drako Breeam, monomando de lavabo, apertura en frío.
Drako Breeam, single-lever basin mixer, cold opening



BRE330403VA1169

33A307017

Caudal
Flow
5 l/min

BREH330403VA1169

33A307026

Caudal
Flow
3.5 l/min

Drako Breeam, monomando de lavabo con válvula automática de inox 1 1/4, apertura en frío.
Drako Breeam, single-lever basin mixer with automatic 1 1/4" stainless steel valve, cold opening.



BRE3310

33A308820

Caudal
Flow
5 l/min

BRE3310NM

33A308821

Caudal
Flow
5 l/min

Drako Breeam, monomando de lavabo L.
Drako Breeam, single lever tall washbasin.



BRE330302

33B307012

Caudal
Flow
5 l/min

BREH330302

33B307023

Caudal
Flow
3.5 l/min

Drako Breeam, monomando de bidé.
Drako Breeam, single lever bidet mixer.



BRE3305S

33C307019

Caudal
Flow
8 l/min

BREH3305S

33C307029

Caudal
Flow
6 l/min

Drako Breeam, monomando de baño-ducha.
Drako Breeam, single lever bath-shower mixer.



BRE3305T3

33C307020

BRE3305S+5840T3+3726+1128C

Caudal
Flow
8 l/min

BREH3305T3

33C307030

BREH3305S+5840T3+3726+1128C

Caudal
Flow
6 l/min

Drako Breeam, conjunto monomando de baño-ducha con equipo de ducha.
Drako Breeam, bath-shower mixer with shower set.



BRE3308S

33D307021

Caudal
Flow
8 l/min

BREH3308S

33D307031

Caudal
Flow
6 l/min

Drako Breeam, monomando de ducha.
Drako Breeam, single lever shower mixer.



BRE3308T3

33D307022
BRE3308S-5840T3-3726-1128C

Caudal
Flow
8l/min

BREH3308T3

33D307032
BREH3308S-5840T3-3726-1128C

Caudal
Flow
6l/min

Drako Breeam, monomando de ducha con equipo de ducha.
Drako Breeam, shower mixer with shower set.



BRE330602

33E308726

Caudal
Flow
5l/min

BRE330602NM

33E308483

Caudal
Flow
5l/min

Drako Breeam, monomando de cocina con caño giratorio.
Drako Breeam, kitchen single-lever mixer with swivel spout.



BRE570223

57A309744

Caudal
Flow
5l/min

New Fly Breeam, monomando de lavabo con apertura en frío.
New Fly Breeam, washbasin mixer, cold opening.



570223 VA1169

57A309745

Caudal
Flow
5l/min

New Fly Breeam, monomando de lavabo, apertura en frío con válvula automática 1/4".
New Fly Breeam, washbasin mixer cold opening with stainless steel pop-up waste 1/4".



BRE570223VA9065

57A309746

Caudal
Flow
5l/min

New Fly Breeam, monomando de lavabo, apertura en frío con válvula automática 1/4".
New Fly Breeam, washbasin mixer cold opening with stainless steel pop-up waste 1/4".



BRE570113

57A305885

Caudal
Flow
5l/min

BREH570113

57A307048

Caudal
Flow
3.5l/min

New Fly Breeam, monomando de lavabo inclinado, sistema S3 apertura en frío.
New Fly Breeam, inclined washbasin single-lever mixer, S3 system cold opening.



BRE570123

57A309689

Caudal
Flow
5l/min

BREH570123

57A309708

Caudal
Flow
3.5l/min

New Fly Breeam, monomando de lavabo inclinado, apertura en frío.
New Fly Breeam, inclined washbasin single-lever mixer, cold opening.



BREH570123VA1169

57A309710

Caudal
Flow
3.5l/min

New Fly Breeam, monomando de lavabo inclinado, con válvula automática de inox 1/4" y sistema S3 apertura en frío.
New Fly Breeam, single lever basin mixer with 1/4" automatic stainless steel valve and S3 cold opening system.



BREH570123VA9065
57A309711

New Fly Breeam, monomando de lavabo inclinado, con válvula automática de ABS 1/4" y sistema S3 apertura en frío.
New Fly Breeam, inclined washbasin single-lever mixer with 1/4" automatic ABS valve and S3 system cold opening.

Caudal Flow 3,5 l/min



BRE570111
57A305887

BRE570111NM
57A305886

BREH570111
57A307046

BREH570111NM
55A307047

New Fly Breeam, monomando de lavabo inclinado.
New Fly Breeam, inclined washbasin single-lever mixer.

Caudal Flow 5 l/min

Caudal Flow 5 l/min

Caudal Flow 3,5 l/min

Caudal Flow 3,5 l/min



BRE570121
57A309681

BRE570121NM
57A309684

New Fly Breeam, monomando de lavabo inclinado.
New Fly Breeam, inclined washbasin mixer

Caudal Flow 5 l/min

Caudal Flow 5 l/min



BRE570121VA1169
57A309714

BRE570121VA9065
57A309683

New Fly Breeam, monomando de lavabo inclinado con válvula automática de ABS 1/4".
New Fly Breeam, inclined washbasin mixer with ABS pop-up waste 1/4".

Caudal Flow 5 l/min

Caudal Flow 5 l/min



BREH570221MED
57A309676

New Fly Breeam, monomando de lavabo con maneta medica.
New Fly Breeam, single-lever basin mixer with medicated handle.

Caudal Flow 3,5 l/min



BREH570221MEDVA1169
57A309677

New Fly Breeam, monomando de lavabo con maneta medica y válvula automática de inox 1/4".
New Fly Breeam, single-lever basin mixer with medical handle and automatic 1/4" stainless steel valve.

Caudal Flow 3,5 l/min



BRE570321
57B309691

BRE570321NM
57B309696

BREH570321
57B309712

BREH570321NM
57B309713

New Fly Breeam, monomando de bidé.
New Fly Breeam, bidet single-lever mixer.

Caudal Flow 5 l/min

Caudal Flow 5 l/min

Caudal Flow 3,5 l/min

Caudal Flow 3,5 l/min



BRE570321VA1169
57B309693

BRE570321VA9065
57B309694

New Fly Breeam, monomando de bidé con válvula automática de ABS 1/4".
New Fly Breeam, bidet single-lever mixer with 1/4" automatic ABS valve.

Caudal Flow 5 l/min

Caudal Flow 5 l/min



BRE570502S
57C305883

Caudal
Flow
5 l/min

BRE570502SNM
57C305888

Caudal
Flow
5 l/min

BREH570502S
57C307052

Caudal
Flow
3.5 l/min

BREH570502SNM
57C307054

Caudal
Flow
3.5 l/min

New Fly Breeam, monomando de baño-ducha.
New Fly Breeam, bath-shower single-lever mixer.



BREH570502SMED
57C307459

Caudal
Flow
3.5 l/min

New Fly Breeam, monomando de baño-ducha con maneta medica.
New Fly Breeam, bath-shower single-lever mixer with medical handle.



BRE570502BTNM
57C305884

BRE570502SNM+2876BTNM+372602NM+2475CNM

Caudal
Flow
5 l/min

BREH570502BTNM
57C307050

BREH570502SNM+2876BTNM+372602NM+2475CNM

Caudal
Flow
3.5 l/min

New Fly Breeam, conjunto monomando de baño con equipo de ducha.
New Fly Breeam, bath single-lever mixer set with shower kit.



BRE570502T1
57C305882

BRE570502S+3520T1+3726+1128C

Caudal
Flow
5 l/min

BREH570502T1
57C307057

BREH570502S+3520T1+3726+1128C

Caudal
Flow
3.5 l/min

New Fly Breeam, conjunto monomando de baño-ducha con equipo de ducha.
New Fly Breeam, bath-shower single-lever mixer set with shower kit.



BRE570802S
57D305879

Caudal
Flow
5 l/min

BRE570802SNM
57D307035

Caudal
Flow
5 l/min

BREH570802S
57D307059

Caudal
Flow
3.5 l/min

BREH570802SNM
57D307061

Caudal
Flow
3.5 l/min

New Fly Breeam, monomando de ducha.
New Fly Breeam, shower single-lever mixer.



BREH570812SMED
57D307461

Caudal
Flow
3.5 l/min

New Fly Breeam, monomando de ducha con maneta medica.
New Fly Breeam, single lever shower mixer with medical handle.



BREH570802BTNM
57D307058

BREH570802SNM+2876BTNM+372602NM+2475CNM

Caudal
Flow
3.5 l/min

New Fly Breeam, conjunto monomando de ducha con equipo de ducha.
New Fly Breeam, shower mixer set with shower kit.



BRE570802T1
57D305910

BRE570802S+3520T1+3726+1128C

Caudal
Flow
5 l/min

BREH570802T1
57D307062

BREH570802S+3520T1+3726+1128C

Caudal
Flow
3.5 l/min

New Fly Breeam, conjunto monomando de ducha con equipo de ducha.
New Fly Breeam, shower mixer set with shower kit.



BRE570611
57E305881

New Fly Breeam, monomando de fregadero con caño alto giratorio.
New Fly Breeam, sink single-lever mixer with high swivel spout.

Caudal
Flow
5l/min



BRE571701CC
57E308728

New Fly Breeam, monomando de fregadero con caño alto 5L.
New Fly Breeam, sink single-lever mixer with 5L high spout.

Caudal
Flow
5l/min



BREH570701CCMED
57E307460

New Fly Breeam, monomando de fregadero mural con caño giratorio y maneta medica.
New Fly Breeam, wall-mounted single-lever sink mixer with swivel spout and medicated handle.

Caudal
Flow
3,5l/min



BRE570901
57E308727

New Fly Breeam, monomando de fregadero con caño giratorio 5L.
New Fly Breeam, sink single-lever mixer with 5L swivel spout.

Caudal
Flow
5l/min



BREH570901MED
57E307462

New Fly Breeam, monomando de cocina con palanca gerontológica.
New Fly Breeam, kitchen single-lever mixer with gerontological lever.

Caudal
Flow
5l/min



BRE571011
57A307036

BRE571011NM
57A307037

BREH571011
57A307063

BREH571011NM
57A307064

New Fly Breeam, monomando de lavabo alto.
New Fly Breeam, tall washbasin single-lever mixer.

Caudal
Flow
5l/min

Caudal
Flow
5l/min

Caudal
Flow
3,5l/min

Caudal
Flow
3,5l/min



BRE510101
51A308307

BREH510101
51A308308

Civic Breeam, monomando de lavabo de 5L.
Civic Breeam, 5L basin mixer.

Caudal
Flow
5l/min

Caudal
Flow
3,5l/min



BRE511001
51A308729

Civic Breeam, monomando de lavabo alto de 5L.
Civic Breeam, 5L tall basin mixer.

Caudal
Flow
5l/min